

ES4-2071 R 4C 2274 4  
RICHARD B FONES JR  
25 BALTIMORE - ANNAPOLIS  
BLVD - FERNDALE  
GLEN BURNIE MD 21061

December, 1974 □ 75 cents

# Electronic Servicing



A HOWARD W. SAMS PUBLICATION



## Principles of video tape recorders

Servicing MATV  
Embarrassing Vertical Roll  
Cassette Workshop

# PTS ELECTRONICS

Precision Tuner Service



now available near you

<p><b>ALABAMA:</b> PTS ELECTRONICS 524 32ND ST. SOUTH BIRMINGHAM, ALA. 35222 TEL. 205. 323-2647</p>	<p><b>CALIFORNIA—NORTH:</b> PTS ELECTRONICS 4611 AUBURN BLVD. SACRAMENTO, CALIF. 95841 TEL. 916. 482-6220</p>	<p><b>CALIFORNIA—SOUTH:</b> PTS ELECTRONICS 5111 UNIVERSITY AVE. SAN DIEGO, CALIF. 92105 TEL. 714. 280-7070</p>	<p><b>COLORADO:</b> PTS ELECTRONICS 4958 ALLISON ST. ARVADA, COLO. 80001 TEL. 303. 423-7080</p>	<p><b>FLORIDA—NORTH:</b> PTS ELECTRONICS 12934 N.W. 7TH AVE. MIAMI, FLA. 33168 TEL. 305. 685-9811</p>	<p><b>FLORIDA—SOUTH:</b> PTS ELECTRONICS 1918 BLANDING BLVD. JACKSONVILLE, FLA. 32210 TEL. 904. 389-9952</p>	<p><b>HOME OFFICE—INDIANA:</b> PTS ELECTRONICS 5233 S. HWY. 37 BLOOMINGTON, IND. 47401 TEL. 812. 824-9331</p>	<p><b>KANSAS:</b> PTS ELECTRONICS 3116 MERRIAM LANE KANSAS CITY, KANSAS 66100 TEL. 913. 831-1222</p>
<p><b>TEXAS—EAST:</b> PTS ELECTRONICS 4324-26 TELEPHONE RD. HOUSTON, TEX. 77032 TEL. 713. 644-6793</p>							<p><b>LOUISIANA:</b> PTS ELECTRONICS 2914 WYCHWOOD DRIVE METAIRIE, LOUISIANA 70033 TEL. 504. 885-2349</p>
<p><b>TEXAS—NORTH:</b> PTS ELECTRONICS MOPAC LANE LONGVIEW, TEX. 75601 TEL. 214. 753-4334</p>							<p><b>MARYLAND:</b> PTS ELECTRONICS 1105 SPRING ST. SILVER SPRING, MD. 20910 TEL. 301. 565-0025</p>
<p><b>TENNESSEE:</b> PTS ELECTRONICS 3614 LAMAR AVE. MEMPHIS, TENN. 38118 TEL. 901. 365-1918</p>							<p><b>MASSACHUSETTS:</b> PTS ELECTRONICS 191 CHESTNUT ST. SPRINGFIELD, MASS. 01103 TEL. 413. 734-2737</p>
<p><b>PENNSYLVANIA—WEST:</b> PTS ELECTRONICS 257 RIVERVIEW AVE. W. PITTSBURGH, PA. 15202 TEL. 412. 761-7648</p>							<p><b>MICHIGAN:</b> PTS ELECTRONICS 13709 W. EIGHT MILE RD. DETROIT, MICH. 48235 TEL. 313. 862-1785</p>
<p><b>PENNSYLVANIA—EAST:</b> PTS ELECTRONICS 1921 S. 70TH ST. PHILADELPHIA, PA. 19142 TEL. 215. 724-0999</p>							<p><b>MINNESOTA:</b> PTS ELECTRONICS 815 N. LAKE ST. MINNEAPOLIS, MINN. 55408 TEL. 612. 824-2333</p>
<p><b>OREGON:</b> PTS ELECTRONICS 5220 N.E. SANDY BLVD. PORTLAND, OREGON 97213 Tel. 503. 282-9636</p>	<p><b>OKLAHOMA:</b> PTS ELECTRONICS 3007 N. MAY OKLAHOMA CITY, OKLA. 73106 TEL. 405. 947-2013</p>	<p><b>OHIO—SOUTH:</b> US TUNER SERVICE 8180 VINE ST. CINCINNATI, OHIO 45215 TEL. 513. 821-2298</p>	<p><b>OHIO:</b> PTS ELECTRONICS 5682 STATE RD. CLEVELAND, OHIO 44134 TEL. 216. 845-4480</p>	<p><b>NORTH CAROLINA:</b> PTS ELECTRONICS 724 SIEGLE AVE. CHARLOTTE, N.C. 28205 TEL. 704. 332-8007</p>	<p><b>NEW YORK CITY—NEW JERSEY:</b> PTS ELECTRONICS 158 MARKET ST. E. PATERSON, N.J. 07407 TEL. 201. 791-6380</p>	<p><b>NEW YORK:</b> PTS ELECTRONICS 993 SYCAMORE ST. BUFFALO, N.Y. 14212 TEL. 716. 891-4935</p>	<p><b>MISSOURI:</b> PTS ELECTRONICS 8456 PAGE BLVD. ST. LOUIS, MO. 63130</p>

## LET US TAKE CARE OF YOUR TUNER PROBLEMS...

PTS will repair any tuner - no matter how old or new - black & white or color - transistor or tubes - varactor or electronically tuned - detent UHF. 8 hour service is a must!

### ...THIS IS THE SERVICE WE OFFER:

1. Fastest Service—8 hour—in and out the same day. Overnight transit to one of our strategically located plants.
2. Best Quality—Your customers are satisfied and you are not bothered with returning tuners for rework.
3. PTS uses only ORIGINAL PARTS! No homemade or make-do, inferior merchandise (this is why we charge for major parts!). You get your tuner back in ORIGINAL EQUIPMENT condition.
4. PTS is recommended by more TV Manufacturers than any other tuner company.
5. PTS is overhauling more tuners than all other tuner services combined.



Fast **8** hr. Service!

We offer you finer, faster...

...Precision  
Tuner Service



ELECTRONICS, INC....

...Number ONE and still trying harder!  
(Not a Franchise Company)

## 1 YEAR GUARANTEE

VHF, UHF \$10.95  
UV-COMBO 17.95  
IF-SUBCHASSIS 12.50

Major parts and shipping charged at cost.  
(Dealer net!)

Over 4000 exact tuner replacements available for \$14.95 up (new or rebuilt).

For More Details Circle (1) on Reply Card

# the only prime time test pattern.

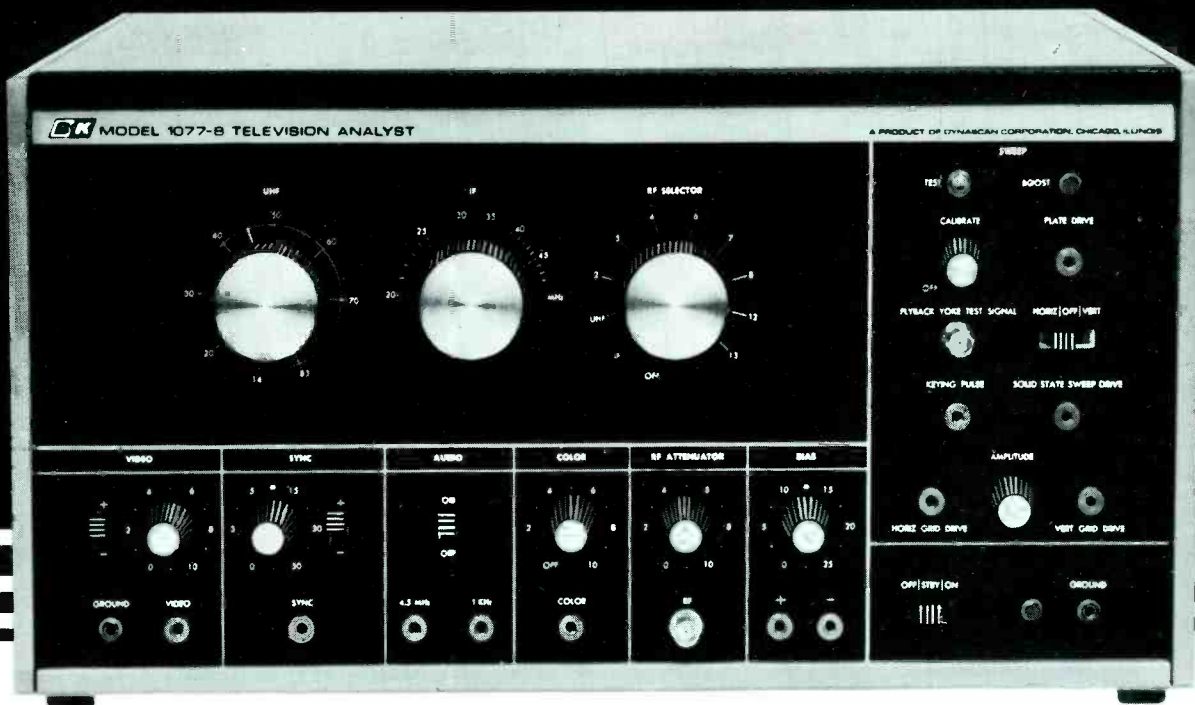

Model 1077B  
\$454

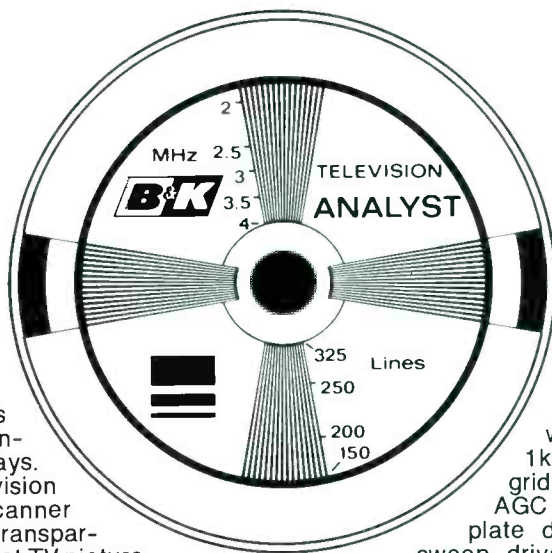

Remember the test pattern? Here's how to use that old standby to cut your troubleshooting time in half.

Broadcast test patterns are available only at very inconvenient times these days. So our Model 1077B Television Analyst has a flying-spot scanner that transforms any 3"x4" transparency into a broadcast-format TV picture. We even supply you with a test pattern slide.

A test pattern provides valuable information about picture size, linearity, focus, resolution, ringing (overshoot), low-frequency phase shift (smear) and frequency response. Unless the TV receiver isn't working, of course.

That's why the 1077B provides signal-substitution outputs to let you inject the test pattern anywhere in the chain from the flyback all the way back to the antenna terminals. You can pinpoint the problem in minutes instead of hours, check-

ing the quality of each stage as you go.

Outputs include: IF, 8 VHF channels, all UHF channels, video, sync, 4.5MHz sound subcarrier with 1kHz FM modulation, 1kHz audio, chroma, vertical grid drive, horizontal grid drive, AGC keying pulse, horizontal plate drive, horizontal solid-state sweep drive, vertical plate drive and vertical solid state sweep drive.

There's also a built-in dot/bar/crosshatch generator for color TV chroma and convergence adjustments. Plus positive or negative bias supply and B+ boost indication. All level controls are conveniently located on the front panel.

There's nothing else like it.

Ask your distributor for Model 1077B, the latest in over 20 years of television analysts—in stock now or write Dynascan.

**B&K** PRODUCTS OF  
**DYNASCAN**

1801 W. Belle Plaine Ave. • Chicago, IL 60613 • Phone (312) 327-7270

Complete Line of Analog and Digital Multimeters, Oscilloscopes, Signal Generators, Semiconductor Testers, Power Supplies, Probes, Tube Testers and Substitution Boxes.

For More Details Circle (4) on Reply Card

# electronic **SCANNER**

news of the industry

---

**GTE Sylvania has acquired the Philco-Ford trademark** and rights to distribute home entertainment products through Philco channels. The agreement does not involve Philco's line of refrigerators and freezers, Telesound operations, or auto products which will continue to be manufactured by Philco. According to industry sources, the combination of the two firms should place Sylvania in the number 4 position in color TV sales.

**United has signed a long-term contract with Bell & Howell** for the installation of aircraft video entertainment systems on all 37 of the carrier's DC-10s. Before take-off, the system can pick up broadcast TV signals. In-flight, full-length movies or other programs will be presented through the use of pre-recorded videocassette tapes.

**A confrontation over video disc players** still is evident between RCA on one side, and Philips and MCA on the other. Philips and MCA are working on a single standardized system that they say hopefully will help eliminate consumer marketing problems that have plagued the product. RCA claims its own system is more simple and utilizes a capacitance pickup instead of the more-expensive laser beam. According to **Home Furnishings Daily**, the video disc player is expected to be the next big growth area in home electronics.

**Television transmission through a glass thread** has been developed by International Telephone and Telegraph Corporation. As demonstrated by Harold S. Geneen, chairman of the board of IT&T, the received signal is virtually identical to the one obtained before the video-modulated laser light was channeled through the spool of "optical fiber". Transmissions up to two miles reportedly now are possible.



Photo courtesy of ITT

(Continued on page 6)

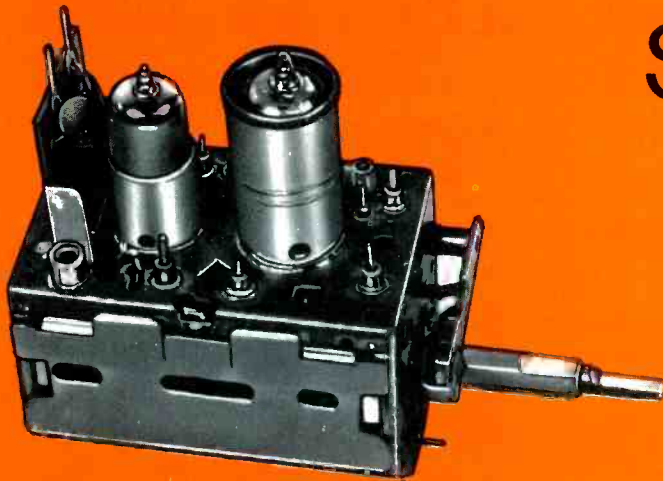

# STILL ONLY \$9.95

**U.S.A. ONLY**  
ALL PARTS INCLUDED  
EXCEPT TUBES  
& TRANSISTORS  
ONE YEAR GUARANTEE

## TUNER SERVICE CORPORATION

PROVIDES YOU WITH A  
COMPLETE SERVICE FOR  
ALL YOUR TELEVISION  
TUNER REQUIREMENTS.

### REPAIR

VHF Or UHF Any Type \$9.95. (U.S.A. ONLY)  
UHF/VHF Combo \$15.00. (U.S.A. ONLY)

In this price all parts are included, tubes, transistors, diodes, and nuvistors are charged extra. This price does not cover mutilated tuners.

Fast efficient service at our conveniently located service centers.

All tuners ultrasonically cleaned, repaired, realigned and air tested.

### REPLACE

Universal Replacement Tuner \$12.95 (In Canada \$15.95)

This price buys you a complete new tuner built specifically by SARKES TARZIAN INC. for this purpose.

All shafts have a maximum length of 10 1/2" which can be cut to 1 1/2".

Specify heater type parallel and series 450mA or 600mA.

### CUSTOMIZE

Customized tuners are available at a cost of only \$15.95; (with trade-in \$13.95) (In Canada \$17.95/\$15.95)

Send in your original tuner for comparison purposes.



WATCH US  
GROW

HEADQUARTERS	BLOOMINGTON, INDIANA 47401	537 S. Walnut Street	Tel. 812-334-0411
ARIZONA	TUCSON, ARIZONA 85713	1528 So. 6th Street, P.O. Box 4534	Tel. 602-791-9243
CALIFORNIA	NORTH HOLLYWOOD, CALIF. 91601	10654 Magnolia Boulevard	Tel. 213-769-2720
	BURLINGAME, CALIF. 94010	1324 Marsten Road	Tel. 415-347-5728
	MODESTO, CALIF. 95351	123 Phoenix Avenue	Tel. 209-521-8051
FLORIDA	TAMPA, FLORIDA 33606	1505 Cypress Street	Tel. 813-253-0324
	HIALEAH, FLORIDA 33013	906 E. 25th Street	Tel. 305-836-7078
GEORGIA	ATLANTA, GEORGIA 30310	938 Gordon Street S.W.	Tel. 404-758-2232
ILLINOIS	CHAMPAIGN, ILLINOIS 61820	405 East University Street	Tel. 217-356-6400
	CHICAGO, ILLINOIS 60621	737 West 55th Street	Tel. 312-873-5556-7
	SKOKIE, ILLINOIS 60076	5110 West Brown Street	Tel. 312-675-0230
INDIANA	HAMMOND, INDIANA 46323	6835 Grand Avenue	Tel. 219-845-2676
	INDIANAPOLIS, INDIANA 46204	112 W. St. Clair St.	Tel. 317-632-3493
KENTUCKY	LOUISVILLE, KENTUCKY 40208	2920 Taylor Boulevard	Tel. 502-634-3334
LOUISIANA	SHREVEPORT, LOUISIANA 71104	3025 Highland Ave.	Tel. 318-861-7745
MARYLAND	BALTIMORE, MD. 21215	5505 Reisterstown Rd., P.O. Box 2624	Tel. 301-358-1186
MISSOURI	ST. LOUIS, MISSOURI 63132	10530 Page Avenue	Tel. 314-429-0633
NEVADA	LAS VEGAS, NEVADA 89102	1412 Western Ave., No 1	Tel. 702-384-4235
NEW JERSEY	NEW JERSEY 07307	547-49 Tonnele Avenue HWY 1&9	Tel. 201-792-3730
	TRENTON, NEW JERSEY 08638	901 N. Olden Ave.	Tel. 609-393-0999
OHIO	CINCINNATI, OHIO 45216	7450 Vine Street	Tel. 513-821-5080
	CLEVELAND, OHIO 44109	4528 Pearl Road	Tel. 216-741-2314
OREGON	PORTLAND, OREGON 97210	1732 N.W. 25th Avenue	Tel. 503-222-9059
TENNESSEE	GREENEVILLE, TENNESSEE 37743	1215 Snapps Ferry Road	Tel. 615-639-8451
	MEMPHIS, TENNESSEE 38111	3158 Barron Ave.	Tel. 901-458-2355
TEXAS	DALLAS, TEXAS 75218	11540 Garland Road	Tel. 214-327-8413
VIRGINIA	NORFOLK, VIRGINIA 23513	3295 Santos Street	Tel. 804-855-2518
CANADA	ST. LAURENT, MONTREAL, QUEBEC H4N 2L7	305 Decarie Blvd.	Tel. 514-748-8803
	CALGARY, ALBERTA, T2H-0L1	448-42nd Avenue S.E., P.O. Box 5823 STN "A"	Tel. 403-243-0971

IF YOU WANT TO BRANCH OUT INTO THE TV TUNER REPAIR BUSINESS,  
WRITE TO THE BLOOMINGTON HEADQUARTERS ABOUT A FRANCHISE  
For More Details Circle (5) on Reply Card

www.americanradiohistory.com

**R.W. Lester, an electronics inventor, has developed a magnetic bubble called Sonadisc**, which supposedly can store up to 1,000 musical selections and also provide instant retrieval. Designed to replace the juke box, the device is the size of a cigar box and should be in production by next year. According to **Home Furnishings Daily**, Lester claims magnetic bubble technology has great potential for audio products of the future. He says conventional recording devices will be obsolete by the end of the decade, and replaced by totally solid-state music reproduction devices.

**Matsushita has developed a cartridge video-tape duplicating system** which permits a copy of a 30-minute tape to be made in less than three minutes. **Radio & Television Weekly** describes the system as consisting of a master tape processor priced in Japan at \$16,700, and a printer priced at \$15,000.

**The National Appliance & Radio TV Dealers Association (NARDA)** has issued the 28th annual Cost-of-Doing-Business survey, which shows that service plays an important profitability role in business. The study shows gross margins for "sales only" firms as only 26.7%, while service departments or service-only firms enjoyed margins of "a shade under 40%", according to **Merchandising Week**.

**Three national electronics service organizations have formed a National Coalition Committee** to fight against what they call "major inequities" in manufacturer's warranties. The groups include the National Association of Retail Dealers of America (NARDA), the National Electronic Service Dealers Association (NESDA), and the National Alliance of TV and Electronic Service Associations (NATESA). The committee was set up to deal with television and audio warranties because of what **Home Furnishings Daily** terms a "seriously worsening problem of profitability in servicing these products".

**Zenith has introduced its first b-w 9-inch diagonal portable** with all-solid state chassis that operates from household AC and from 12-volts DC in an automobile. An 8-foot adapter cord can be plugged into the cigarette lighter of an auto for "stop-and-watch" TV viewing.

**Home Furnishings Daily reports that color TV manufacturers are limiting production** in an effort to keep inventory under control despite fewer sales. The decline in color TV sales for the year to date is 7.5%, and monochrome sales are down 8.5%.

**Japanese home-electronics firms and parts makers are cutting back production** in preparation for a long winter of depression, reports **Home Furnishings Daily**. The business slump especially has affected sales of color TV sets. Manufacturers of color TV's are said to be operating under a 25% cutback, compared to last year, and it's predicted that domestic demand might dip below the 5-million-set mark, compared to 6.5 million sets sold last year. Sales of stereo and tape recorders are doing fairly well. □

# letters to the editor

Dear Editor:

Recently, I ran across this short article and thought you might want to pass it along to your readers:

*"Be thankful for the troubles of your job. They provide about half your income, because if it were not for the things that go wrong, the difficult people you have to deal with, and the problems and unpleasantness of your working day, someone could be found to handle your job for half of what you are being paid.*

*It takes intelligence, resourcefulness, patience, tact and courage to*

*meet the troubles of your present job.*

*If all of us would start to look for more troubles and learn to handle them cheerfully and with good judgment as opportunities rather than irritations, we would find ourselves getting ahead at a surprising rate, for it is a fact there are plenty of big jobs waiting for men who are not afraid of the troubles connected with them."*

By the Rev. John Wesley Ford

Sincerely yours,  
John R. Dufour  
Flat Rock, Michigan

## An Open Letter to Ed Terrien: (Page 14, September, 1974 Electronic Servicing)

*You seem to have a rather tiny grasp of the overall warranty picture. If you would multiply your operation by as little as one hundred, you would have some idea of the enormous number of claims which are processed monthly by a distributor or manufacturer.*

*We do not correct claims because we don't have time. Secondly, we are not mind-readers; nor can we act as your agent.*

*Your warranty claim is very much like a check; properly completed and endorsed it represents money...your money!*

*Model numbers are important. Very often a subtle change in a model number indicates a different chassis and an entirely different warranty!*

*All participating service centers receive a master list which details the warranty coverage by model. Those who use it do not have problems with model numbers.*

*Try to think of the serial number as the receiver's name (the computer does). With the proper information, changes in production can*

*be made, eliminating possible problems in the field.*

*We do not invite incompetence by claiming that all intermittent problems are "major" repairs. After all, even a poor technician can change all of the modules in less than ten minutes. Of course, by replacing them one at a time, he can locate the problem.*

*Claims are analyzed by people... not computers. If you experience a parts delay, please make a note on your claim form. No distributor or manufacturer expects to have every part in stock.*

*If you find that the service rates you are receiving from a manufacturer or his representative are not enough, then, by all means, do not do the work!*

*Overall you will find that in most cases the manufacturer is paying top-dollar for a job well done. Remember: we do not do your job nor do we expect you to do ours.*

Very Truly Yours,  
Thomas P. Brutscher  
Field Service Supervisor  
for a major brand.

(Continued on page 57)

## Your comments and ideas are welcome.

Address your letters to:

Carl Babcoke, Editor Electronic Servicing  
1014 Wyandotte Street Kansas City, Missouri 64105

# FREE EICO CATALOG

## 346 Ways To Save On Instruments!

EICO's Test Instruments line is the industry's most comprehensive because each instrument serves a specific group of professional needs. You name the requirement—from a resistance box to a VTVM, from a signal tracer to a scope, from a tube tester to a color TV generator, etc., you can depend on EICO to give you the best professional value. Compare our latest solid state instruments at your local EICO Electronics Distributor, he knows your needs best—and serves your requirements with the best values!

**"Build-it-Yourself" and save up to 50% with our famous electronic kits.**

For latest EICO Catalog on Test Instruments, Automotive and Hobby Electronics, Eicocraft Project kits, Burglar-Fire Alarm Systems and name of nearest EICO Distributor, check reader service card or send 50¢ for fast first class mail service.

EICO—283 Malta Street,  
Brooklyn, N.Y. 11207

30 years of service to the Professional Serviceman.



For More Details Circle (7) on Reply Card

ALL NEW FROM ENDECO  
the desoldering  
iron with a  
light



Exclusive new safety light  
shows when power is on  
MODEL 510 \$15.95 NET

Three-way on-idle-off switch • Operates at 40w; icles at 20w for longer tip life • 8 tip sizes available to handle any job • Cool, unbreakable polycarbonate handle • Burn-resistant neoprene cord • Exclusive new bracket insures alignment, prevents damage • 8½" long, 3 ½ oz • Also soldering irons and soldering/desoldering kits.

To locate your nearest distributor  
call toll-free 800-645-9200

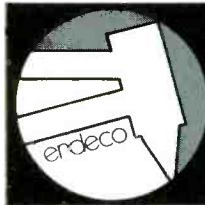

5127 EAST 65TH ST.  
INDIANAPOLIS,  
INDIANA 46220  
PHONE 317/251-1231

enterprise  
development  
corporation

For More Details Circle (9) on Reply Card

## troubleshootingtips

Send in your helpful tips—we pay!

### Low voltage, no sound or picture Silvertone 528.72660 (Photofact 1091-3)

No sound and no raster were the symptoms, although some noise could be heard at high settings of the volume control. After a few preliminary tests, I measured the +420 volt supply and found it was only about +210. I pulled the chassis out enough to reach the low-voltage bridge rectifiers and found the AC input to be about 190 volts instead of the expected 320 volts RMS. Based on this information, the set was pulled into the shop for installation of a new power transformer.

I dislike replacing such an expensive component without strong proof it is bad, so I checked the DC resistance of primary and secondary windings. The readings were within tolerance, and yet the output AC was very low. As I was thinking over these facts, I idly flipped the instant-on switch to the off position (as a kind of non-thinking move of frustration), and was surprised to see the output voltage drop to zero. Yet the on/off switch was still on, and there should have been voltage.

This new information caused me to examine more carefully the power wiring, and I found that one of the ears of the on/off switch that moves the switch from one position to the other was broken off. The switch was feeding power to the whole primary winding at all times, and only the secondary (which supplies the rectifiers) was being turned on and off. The set was

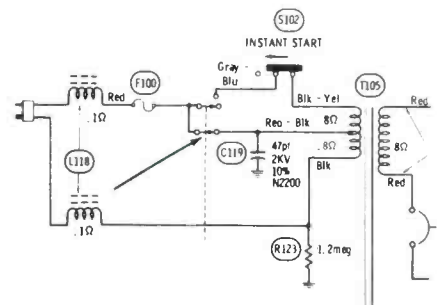

trying to run on standby power, and could not.

I repaired the switch, and delivered the receiver at a price far below the original estimate.

L. W. Fielden  
Port Orchard, Washington

### Insufficient height Zenith 16Z8C50 (Photofact 1074-3)

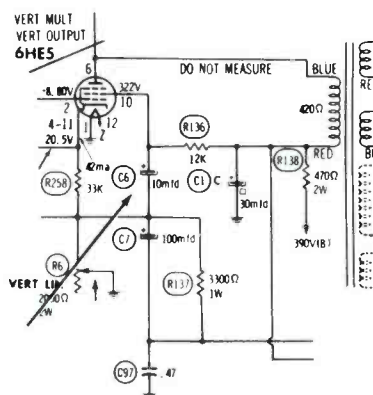

At the bottom of the picture was about 2 inches of blank screen, and the linearity was spread at the top.

I checked DC voltages and resistances, but found none out of tolerance. Grid drive at the output tube was normal.

There are several electrolytics in the output stage of the vertical-sweep circuit, and when I paralleled C6 the picture filled out at the bottom. C6 was open, and a new one took care of the problem.

Peter Sargent  
Bellflower, California

### MOVING?

Send your new address to:

Circulation Dept.  
Electronic Servicing  
1014 Wyandotte Street  
Kansas City, Missouri  
64105

**Polaris**  
**40 KV**  
DUAL RANGE  
**Probe**

Current &  
Voltage Reading  
For Today...  
And Tomorrow!

MODEL 651 \$29<sup>95</sup>

RANGE NO. 1: 40,000 VOLTS DC  
RANGE NO. 2: 0-400 MA DC

Send literature and name of my distributor.

**Polaris New York**  
2862 FULTON STREET  
BROOKLYN, N.Y. 11207

Name \_\_\_\_\_  
Address \_\_\_\_\_  
City \_\_\_\_\_ State \_\_\_\_\_  
Zip \_\_\_\_\_

For More Details Circle (10) on Reply Card

ELECTRONIC SERVICING



# Avoid serious trouble in color TV sets by using the right replacement capacitor!

polyester film

SPRAGUE  
TYPE PP  
polypropylene film

SPRAGUE  
TYPE PM  
polycarbonate film

This capacitor is **GREAT** for 90% of your film capacitor replacements. But . . . it's **NOT** designed for certain critical applications.

These capacitors are a **MUST** for critical commutating and S-shaping applications.

The next time you replace a dipped tubular in one of the newer color TV sets, don't automatically assume you're replacing an ordinary every-day film or paper capacitor. If it happens to be a deflection capacitor used for commutating or S-shaping, you need a polypropylene or polycarbonate film replacement with (1) high a-c current-carrying capability; (2) close capacitance tolerance; (3) good capacitance stability. The standard replacement

capacitors used in the industry, even our superior Type PS dipped tubulars, just won't do the job . . . and they could cause the set to become inoperative again.

Play it safe . . . dipped tubulars may look alike on the surface, but there can be a big difference in the film dielectric. Keep a supply of Sprague Type PP and PM capacitors on hand for those critical situations where ordinary replacements won't work.

## SPRAGUE TYPE PP POLYPROPYLENE FILM TYPE PM POLYCARBONATE FILM CAPACITORS

$\mu\text{F}$ @ WVDC	Cap. Tol.	D. x L.	Cat. No.	$\mu\text{F}$ @ WVDC	Cap. Tol.	D. x L.	Cat. No.
1.75 @ 100	$\pm 5\%$	.900 x 1.000	PM1-M1.75	.0039 @ 600	$\pm 5\%$	.400 x .800	PP6-D39S
1.5 @ 150	$\pm 5\%$	.800 x .937	PM15-M1.5	.01 @ 600	$\pm 5\%$	.500 x 1.250	PP6-S10S
.01 @ 400	$\pm 5\%$	.400 x .750	PP4-S10	.066 @ 600	$\pm 5\%$	.800 x 1.250	PP6-S66S
.015 @ 400	$\pm 5\%$	.450 x .750	PP4-S15	.075 @ 600	$\pm 5\%$	.750 x 1.250	PPS-S75S
.033 @ 400	$\pm 5\%$	.500 x .750	PP4-S33S	.022 @ 800	$\pm 3\%$	.600 x 1.300	PP8-S22S
.06 @ 400	$\pm 5\%$	.800 x 1.250	PP4-S60S	.047 @ 800	$\pm 5\%$	.700 x 1.250	PP8-S47S
.081 @ 400	$\pm 2\%$	.600 x 1.300	PP4-S81S	.051 @ 800	$\pm 5\%$	.800 x 1.250	PP8-S51S
.2 @ 400	$\pm 5\%$	.700 x 1.700	PP4-P20	.0018 @ 1600	$\pm 5\%$	.500 x 1.300	PP16-D18
.0018 @ 600	$\pm 5\%$	.400 x .750	PP6-D18S	.002 @ 1600	$\pm 5\%$	.500 x 1.300	PP16-D20
.0022 @ 600	$\pm 5\%$	.400 x .750	PP6-D22S	.0033 @ 1600	$\pm 5\%$	.550 x 1.300	PP16-D33
				.0039 @ 1600	$\pm 5\%$	.600 x 1.300	PP16-D39

For cross-reference information on close-tolerance polypropylene and polycarbonate film capacitors, showing original part numbers with correct Sprague replacements, ask your Sprague distributor for Cross-Reference Guide C-873, or write to: Sprague Products Company, 509 Marshall Street, North Adams, Mass. 01247.

THE BROAD-LINE PRODUCER OF ELECTRONIC PARTS

For More Details Circle (6) on Reply Card



Chassis—RCA CTC46  
PHOTOFACT—1243-2

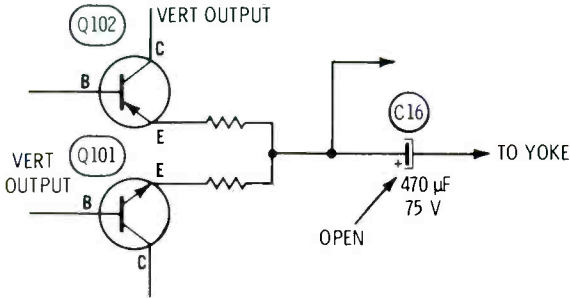

**Symptom**—No vertical sweep  
**Cure**—Check C16, and replace it if open

Chassis—RCA CTC58  
PHOTOFACT—1365-1

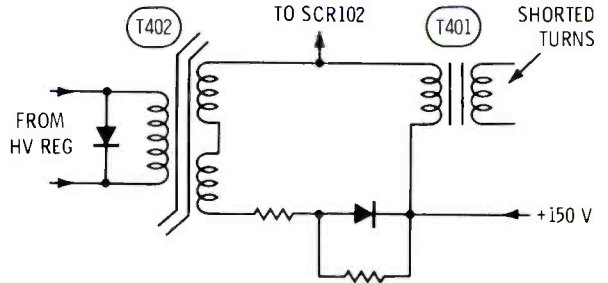

**Symptom**—Narrow width and squeal  
**Cure**—Check T401 for shorted turns, or replace

Chassis—RCA CTC49  
PHOTOFACT—1187-2

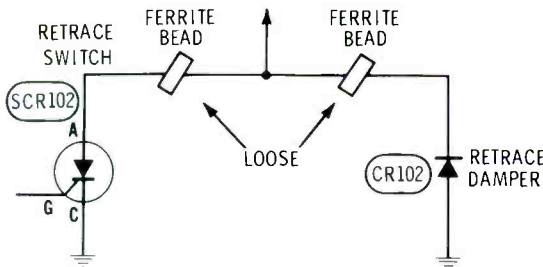

**Symptom**—High-frequency squeal from horiz sweep  
**Cure**—Check ferrite beads on leads of SCR102 and CR102, and cement them if loose

Chassis—RCA CTC58  
PHOTOFACT—1365-1

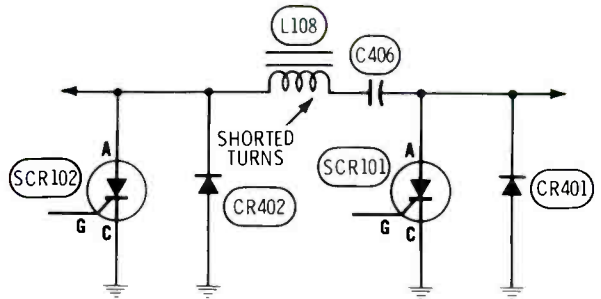

**Symptom**—Narrow width  
**Cure**—If L108 runs warm because of shorted turns, replace it

Chassis—RCA CTC40  
PHOTOFACT—1111-3

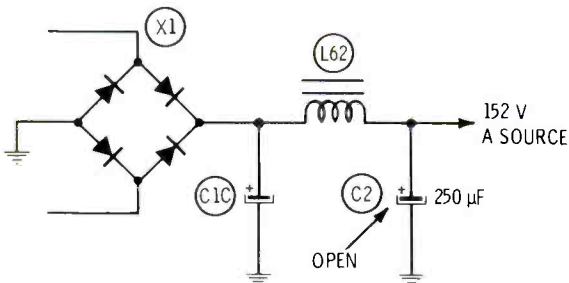

**Symptom**—Repeated failures of SCR101  
**Cure**—Check for excessive ripple on 152-volt line, and replace C2 if it is open

Chassis—RCA CTC48  
PHOTOFACT—1300-2

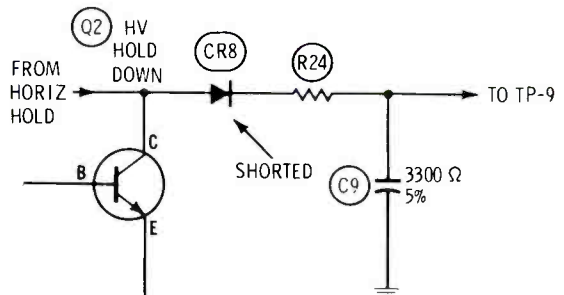

**Symptom**—Circuit breaker open shortly after turn-on  
**Cure**—Check CR408, and replace it if open

# readers'exchange

**Needed:** Operating manual, schematic, and parts list for an Ampro Corporation sound movie projector, Premier 20.

Harold E. Brown  
R.R. 1, Box 145P  
Palmerton, Pennsylvania 18071

**Needed:** Schematic for Knight lab scope, Model 83Y611, with dual-trace plug-in, Model 83Y614. Will pay cost.

F.G. Buckendorff  
535 Lesterwest Way  
Glendora, California 91740

**Needed:** Schematic and service data for Symphonic Model TPS-700 miniature B/W TV.

J.D. Williams  
9101 Aspen Avenue NE  
Albuquerque, New Mexico 87112

**Needed:** Accurate Model 257 tube-tester. Write for list of radio and TV tubes.

S. Barzel  
428 West Roosevelt Boulevard  
Philadelphia, Pennsylvania 19120

**Needed:** Schematic for Sanwa Electric Instrument Company VOM, Model K-30d.

CW2 Clifford Burgess  
Stagecoach Park  
R.R. 1 Box 27  
Killeen, Texas 76541

**Needed:** Power transformer for Hallicrafter amateur receiver SX-140, part number 052-000853-1052-62.5.

Reynold G. Smith  
71 South Union Street  
Rockland, Massachusetts 02370

**Needed:** Used test equipment. Also, have old radio and TV tubes for sale or trade.

Williams Radio & TV Service  
106 South Jefferson Street  
Lewisburg, West Virginia 24901

**Needed:** Schematic and operating instructions for oscilloscope AM/USM-SOC manufactured by Sentinel Electronics. Also need address of manufacturer.

Roy Watts  
Rt. 1  
Jet, Oklahoma 73749

**Needed:** Schematic and two tubes for RCA Radiola III, an antique, regenerative radio.

Stephen Patrick  
10 Stokes Avenue  
Binghamton, New York 13905

**Needed:** Schematic for Commodore TV model PTV-12.

Fred's TV  
108 West Trident Boulevard  
Neptune, New Jersey 07753

(Continued on page 55)

## What will you look for in your next service scope?



## Heath's 4510 has the performance and features you need to tackle just about any service job.

A good service scope should be more than just a visual voltmeter. It should have the performance necessary to troubleshoot today's sensitive circuits. Our 4510 has DC-15 MHz bandwidth, 1 mV/cm sensitivity, time base sweep to 100 ns/cm and complete dual trace capability. And many features that other manufacturers don't provide at anywhere near the price.

The post-deflection accelerated CRT prevents hard-to-read waveforms by providing a brighter trace... and faster writing speeds to match those high-speed logic signals.

Triggering is no problem since trigger bandwidth is typically 45 MHz and is *guaranteed* to 30 MHz. And with the digitally-controlled triggering circuits, there's no stability control to keep adjusting.

With a X10 probe, the 4510's 1 mV/cm sensitivity allows you to read waveforms down to 10 mV/cm. With most other scopes, it's impossible to get below 50 or 100 mV/cm.

Pulse analysis can be difficult — but not with the 4510. Internal delay lines allow display of at least 20 ns of the pretriggered waveform, insuring that the complete waveform is displayed.

The best part of the 4510 is its low price — only \$549.95\* for the kit-form IO-4510, \$750.00\* for the factory assembled SO-4510. Either one gives you the service scope performance you need at a very practical price.



### Send for your free Heath catalogs

Our '75 Heathkit Catalog describes the world's largest selection of electronic kits — including a full line of lab and service instruments. The latest Heath/Schlumberger Assembled Instruments Catalog features a complete line of high performance, low cost instruments for industrial and educational applications. Send for your free copies.

HEATH COMPANY  
Dept. 25-12  
Benton Harbor, Michigan 49022

HEATH  
Schlumberger

- Please send the 1975 Heathkit Catalog  
 Please send the latest Heath/Schlumberger Catalog

Name \_\_\_\_\_  
Title \_\_\_\_\_  
Company/Institution \_\_\_\_\_  
Street \_\_\_\_\_  
City \_\_\_\_\_ State \_\_\_\_\_ Zip \_\_\_\_\_

\*MAIL ORDER PRICES; F.O.B. FACTORY.  
PRICES & SPECIFICATIONS SUBJECT TO CHANGE WITHOUT NOTICE.

TE-313

For More Details Circle (8) on Reply Card

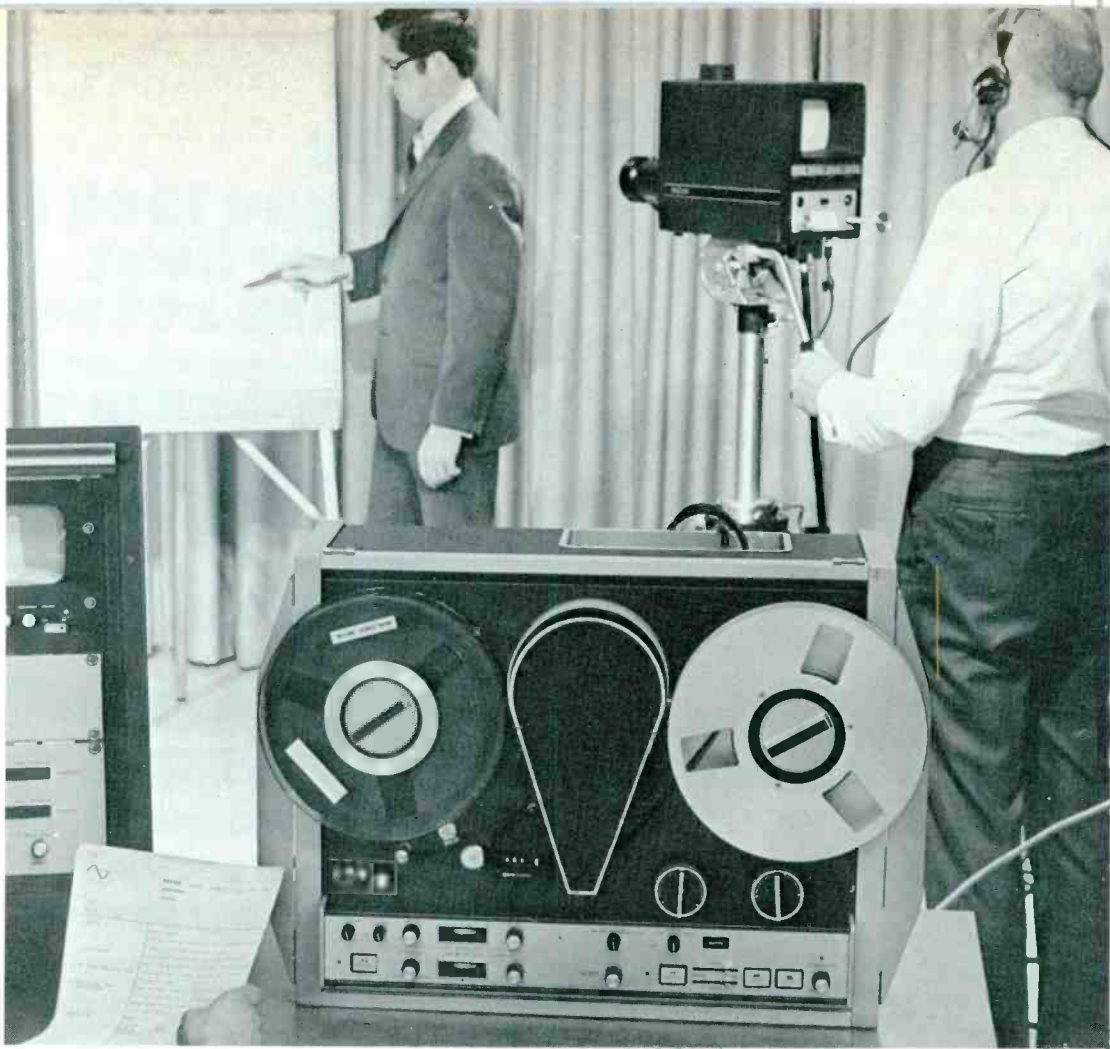

Taping educational seminars is one important use for video tape recorders. (Courtesy of Ampex Corporation)

# Principles and servicing of video tape recorders Part 1

By Carl Babcoke

*Almost all TV programs (except old movies) originate from video tape recorders. These VTR's are of immense value to the broadcasting industry, as indicated by price tags ranging up to about \$100,000. A more quiet revolution has occurred in the growth of educational and business uses for video recorders. No large demand for home VTR's has developed, but video discs are said to be only a year or so away from the marketplace. Perhaps they will be the practical answer for consumer uses. It is time we TV technicians learned the theory and servicing of VTR's. Part 1 gives basic information about both audio and video recording.*

The recording of video or TV programs onto magnetic tape is a natural extension of audio tape recording. But don't let the familiar appearance of a video tape recorder (VTR) fool you. It's simply not possible to upgrade an audio recorder so it will record video satisfactorily. There are too many distinctive differences, both of theory and of mechanical tolerances.

However, it's easier to understand video recording by comparing it to audio recording. That's the reason the basics of both are presented here, in condensed form.

## **Tape Recording At Audio Frequencies**

Magnetic recording started back

in 1893 when Valdemar Poulsen invented the first magnetic recorder. Although it was a new and completely-unique device, it was too far ahead of other technologies to become useful for many years. The availability of vacuum tubes, a change of recording medium to wire, plus the inventions of DC and AC bias (to reduce distortion) finally made magnetic recording a practical reality. Evolutionary changes to tape made of iron oxide coated on paper, and then to plastic base materials, permitted satisfactory recordings of both voices and music.

A change from tubes to transistors freed portable recorders from the limitations of the wall

power source, and multiplied the number of audio recorders sold and used.

### A long magnet

Any magnetic recording consists of variations of magnetic intensity along the length of a long, skinny magnet. Figure 1 shows how the magnetism might be distributed along a section of tape. Modern recorders magnetize the iron particles of the tape during recording by sending an audio current through a head that is fashioned roughly like two horseshoe magnets, with the tips placed together and coils of wire around each horseshoe (Figure 2). However, the cores are made of laminated or powdered iron, and should not retain magnetism when there is no current in the coils.

To reduce the natural non-linearity of the magnetization process (which produces excessive distortion), a supersonic AC signal (bias) is fed along with the audio signal to the head during recording. The frequency should be from 3 to 10 times that of the highest audio



Fig. 1 Varying current through the recording head magnetizes the particles of iron oxide, leaving areas of strong and weak magnetization that can be "read" during playback.

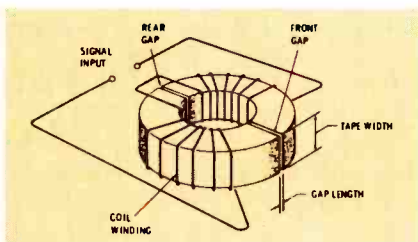

Fig. 2 Audio recording heads are made with two halves of laminated-iron or powdered-iron cores, and one winding on each half. This is essentially a toroid, and is not sensitive to picking up hum from external fields.

All the line drawings are reproduced by permission of Howard W. Sams & Co., Inc. from book number 21024 "Video Tape Recorders" by Harry Kybett.

tones to be recorded. There is no perfect agreement among the experts as to why the bias reduces the distortion. But, it certainly does so.

Magnetic fields from the head are concentrated at the two gaps between sections of the core. In practice these gaps are filled with a solid substance to prevent tape scrapings from filling the front gap and to keep the spacing always the same.

The gap that contacts the tape causes the designers many headaches.

### Gap trade-offs

To concentrate maximum magnetic flux across the gap, a wide gap (perhaps 1 to 10 mils) would be preferable. Unfortunately, such a wide gap would produce very poor high-frequency response. Perhaps the information of Figure 3 will explain why this is true.

At the other extreme, a narrow gap attenuates the low frequencies, because the rate of magnetic change is so slow (that's another way of saying that the head induc-

tance decreases with lower frequencies).

In practice, a compromise head gap is about 0.75 mil.

### Response not flat

The response of a magnetic tape system (recording and playback) falls off at both ends of the audio spectrum, if not compensated by frequency-boosting circuits in the amplifiers (Figure 4).

### Magnetic fields depend more on signal current than on voltage.

Therefore, magnetic recording is done with current that is the same for all frequencies (constant current). Head inductance rises with higher frequencies, so the audio signals usually are fed to the head through a resistor large enough to swamp out the head effect. Constant-current recording gives flat low-frequency response on the tape; the roll-off is in playback.

Loss of high frequencies is a combination of many factors, during both recording and playback. Here is a partial list:

- amplitude and frequency of the AC recording bias;

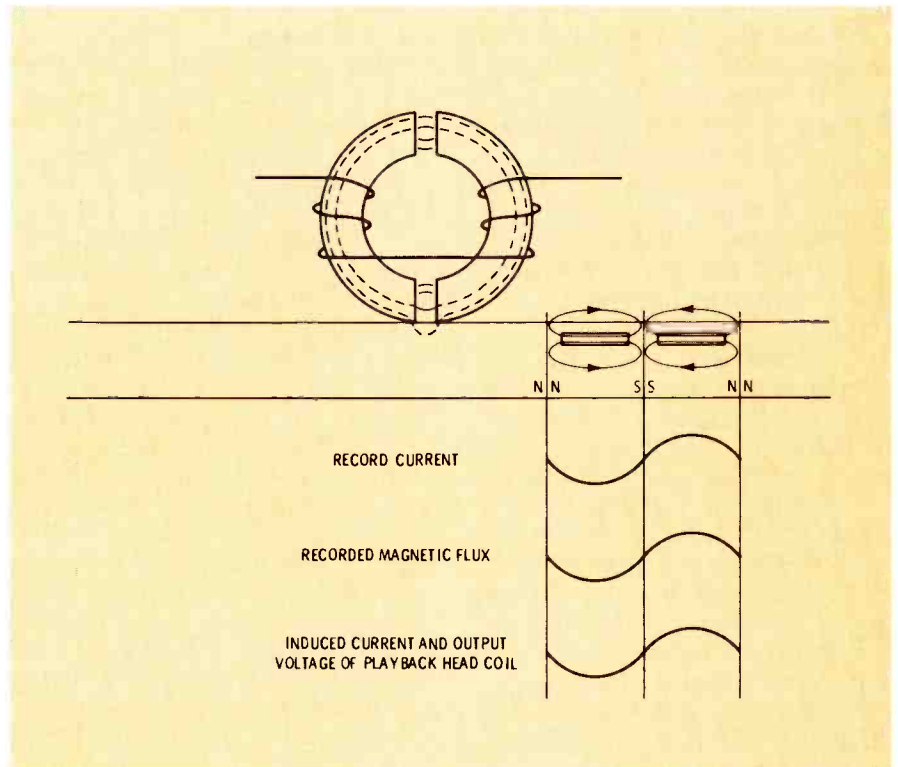

Fig. 3 It's impossible to record a sine wave that occupies less space than the width of the gap. That's called the "extinction" frequency.

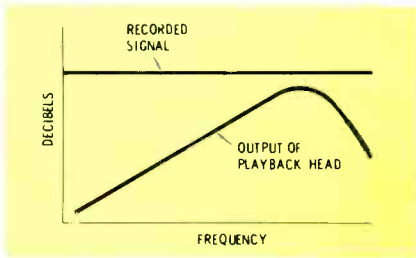

Fig. 4 A tape that has been recorded with constant current (equal magnetic fields for all frequencies) will have a roll-off of both high and low frequencies (unless compensated) when played.

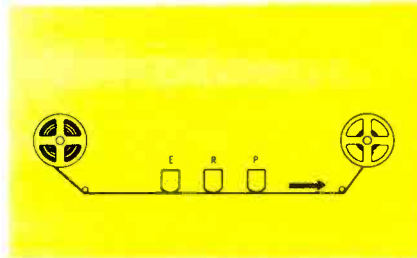

Fig. 5 The tape moves past the erase head, record head, and the playback head in that order. Some machines use one head for both record and playback functions.

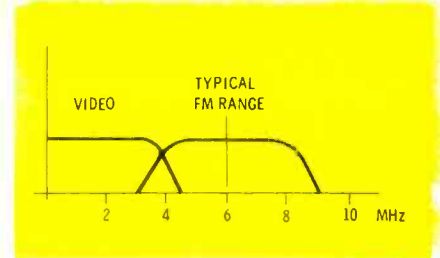

Fig. 6 Frequency modulating a carrier is an excellent way of reducing the 150,000-to-1 ratio of video frequencies to only 2-to-1.

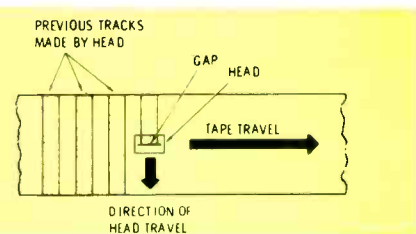

Fig. 7 One way of obtaining a high head-to-tape speed at a slow tape speed is to rotate the head in a circle perpendicular to the length of tape, making tracks across the width. However, more than one head must be used to avoid gaps.

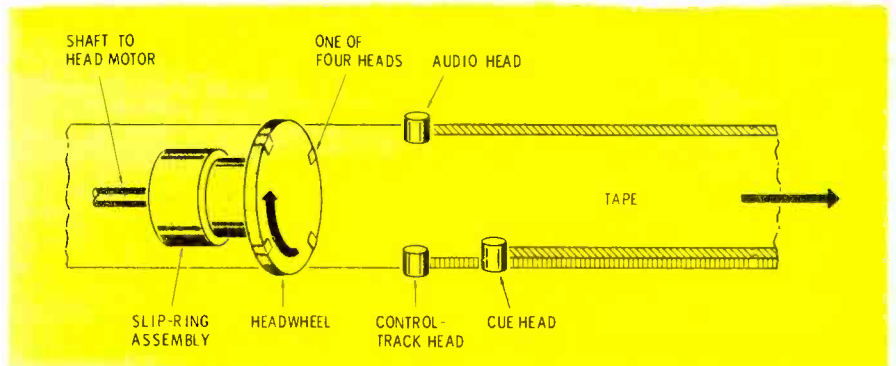

Fig. 8 Four heads equally spaced around a wheel rotating inside a curved wide tape provide overlap between tracks of the heads.

- type of tape coating (including the thickness);
- contact between head and tape;
- any difference of azimuth between record and playback;
- width of the gap relative to the head/tape speed;
- self-demagnetization of the tape.

**Of these, the gap width versus speed is the most important.**

#### Maximum bandwidth

In practice, the "best" compromise of head characteristics are chosen. Then, high-frequency boost during recording, and low-frequency boost during playback are added to flatten the response at both ends.

There are pragmatic limits to the amount of compensation that can be applied to extend the response. It's impossible to record video frequencies this way, for example.

A response of 20 Hz to 20 KHz (10 octaves) is about the limit possible for a high-quality professional-type recorder running at 15 inches-per-second.

#### Bias and erasing

More compromises are necessary for the AC bias during recording. Increased bias amplitude reduces the distortion of the recorded audio. Unfortunately, it also reduces the high-frequency response. And, different amounts of bias are required for optimum results with various coatings.

For obvious reasons, recording is best done on blank areas of the tape. Every recorder has an erase head (on the supply-reel side of the recording head—see Figure 5) that operates either from an AC super-sonic signal, or from DC current. DC or permanent-magnet erase often is used in low-cost models where the increased noise is tolerable. Where multiple tracks are used, the erase head wipes out only one (or one pair, in stereo). Bulk erasers are available for demagnetization of whole reels or cartridges. These erase all tracks at one time.

Amplitude of the erasing voltage must be several times that required

for recording. The frequencies for record and erase must be identical to prevent audible beats, so most recorders supply both from one circuit.

#### Noise problems

Very little noise is caused by the recording process, with the exception of bias effects. AC bias produces the lowest amount of noise, but it must be a very-pure sine wave for best results.

Output signal from a head during playback is only about 1 millivolt. You can see the possibilities of transistor and resistor noise, plus hum (from the head and any unshielded wiring) that's made worse by the large amount of bass boost.

Width of the magnetic track is one factor determining the volume obtained during playback. Reducing the track width decreases the desired signal more than it does the tape hiss, resulting in a degraded signal-to-noise ratio.

In a well-designed audio tape

recorder, the tape hiss is the most annoying noise remaining.

### Mechanical considerations

First requirement of any tape transport is that the tape pass the head at a very-even, very-accurate rate of speed. Any speed deviation results in a change of signal frequency (pitch). Slow speed changes cause "wow", and fast speed or amplitude changes sound as "flutter". Average speed is determined mainly by rotation of the capstan drive.

In addition, each reel must have slip clutches for proper spooling during forward and fast-rewind functions, plus brakes to stop the motion without spilling or breaking the tape.

### Video Bandwidth On Tape?

Audio frequencies of 20 Hz to 20 KHz represent a ratio of 1,000-to-1, while video frequencies of 30 Hz to 4.5 MHz have a ratio of 150,000-to-1.

One of the first ideas proposed was to run the tape by the head at a faster speed. **If no change of gap is provided, the tape would have to move at 2,250 inches per second, requiring 360,000 feet of tape for a one-hour TV recording!** Obviously, this was no solution.

Several other ideas received a limited amount of acceptance. One was to split up the video band, recording each with a separate head and electronic circuits designed for optimum results for the various bands. Finally, **one general method has been adopted: frequency modulation around a higher center frequency.**

### Frequency Modulation

Suppose a carrier with a resting frequency of 7.5 MHz is modulated to swing between 5 MHz and 10 MHz. This is a bandwidth of 5 MHz, but the frequency ratio is only 2-to-1! Virtually no compensation would be required for flat response over that band. In addition, the amplitude limiting possible with FM would minimize the amplitude variations and dropouts from erratic contact between head and tape or from tape variations. No AC bias is required; the FM

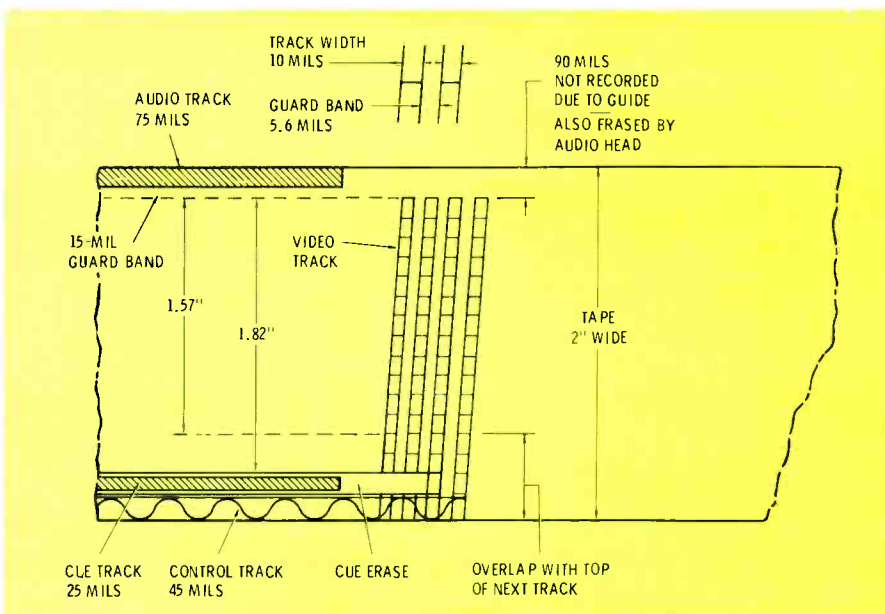

Fig. 9 This is the arrangement of the three longitudinal tracks and the nearly-perpendicular video tracks of a quad-head recorder.

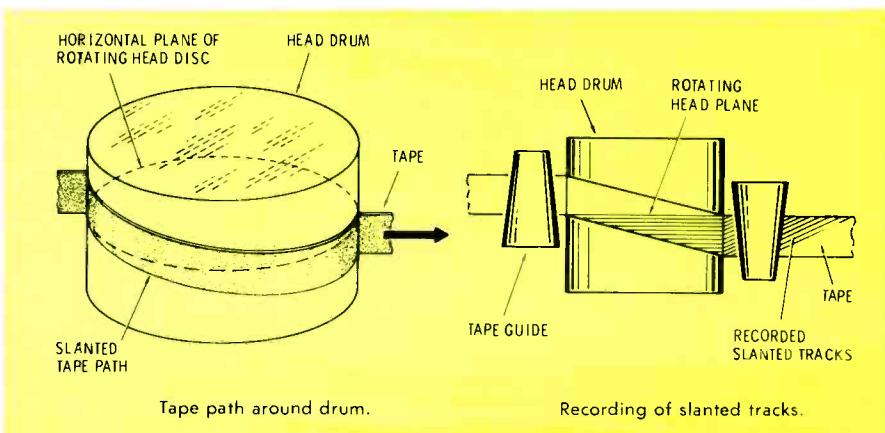

Fig. 10 Principle of the helical (or slant-track) video recorder is to obtain a track long enough to record satisfactorily one vertical field by wrapping a half or full turn of tape at an angle around a motionless drum and using a rotating head operating through a slot in the drum. The resulting tracks are long, and are slanted relative to the tape.

carrier operated at tape saturation is the only bias needed, and both distortion and modulation noise are low.

FM operation seemed to solve all major problems except one. A carrier in the low megaHertz range was required; therefore, a high tape speed and a narrow head gap still were essential.

Helical-scan machines (the main subject of our coverage later) usually have a 4 MHz swing around a lower center frequency (Figure 6).

### Four-Head Machines

One novel system for moving a single head **across** the tape width (traverse movement) at high speed while the tape traveled more slowly is illustrated in Figure 7. Of course, the head had to finish its circular movement without contacting the tape, leaving no signal for about 80% of the time.

Although the original idea was not workable, it was the basis for two designs: the quad-head with tracks almost straight across the tape; and the helical-scan whose

tracks are diagonal across the tape.

### Broadcast Quad-Head Recorder

The mechanical and electronic difficulties of obtaining good quality TV pictures from quad-head recorders seemed insurmountable. Even so, in 1956 the first commercial quad-head recorder for use in TV stations was developed. It was the Model 1000 Ampex, and it met with instant approval from broadcasters.

However, I remember I was less than enthusiastic about it at first. It was for b-w pictures only, at a time when color was struggling to get started. And it caused a sideward zig-zag of vertical lines in the picture at the points where head switching occurred. Try to explain that to an angry owner of a new TV. "My old set didn't do that!"

Later, several companies developed recorders that would handle color, and finally the bugs were eliminated so most of the color banding was gone. Many programs today are so good technically that you can't be certain whether it is "live" or on tape.

### Quad-head mechanisms

Figure 8 shows a simplified view of a quad-head mechanism. Notice that the audio, cue, and control tracks are recorded by fixed heads in the same way as in audio recorders.

The two-inch tape is held in a curve (to lengthen the time each head is in tape contact) around the head wheel. Air suction, a curved shoe, and various guides operate to maintain accurate positioning of the tape. Slip-ring connections furnish video paths for the heads.

One head does not quite leave the tape before the next head enters at the other side. This permits some overlap of the signals, and prevents blank spots. Electronic switching at the front porchs of appropriate horizontal blanking pulses (where it cannot be seen in the picture) selects video from the head which is scanning the tape.

The video tracks are very narrow, and the heads during playback **must** trace the same tracks precisely. Correct playback is much more

difficult than recording, and most of the problems arise there.

During recording, a reference signal is obtained (usually from the vertical-sync pulses of the video being recorded), and then is used in two ways. One sample is compared in a phase-sensitive circuit with pulses obtained from rotation of the head wheel. A DC error-correcting signal from the phase-comparison circuit controls the speed of the head motor so the vertical-sync pulses are recorded at the center of the head travel across the tape. Another sample of the reference signal is recorded by a conventional head for use during playback.

When used in the playback mode, the signal from the control track and the one from the head wheel are fed to a phase-comparison circuit, and the resulting DC control voltage operates through the servo system to regulate the speed and phase of the head-wheel motor.

Sound complicated? Large books could be written about the electronics and mechanisms of quad-head recorders.

Tape speed is 15 inches-per-second, head-to-tape speed is about 1500 IPS, 32 tracks are required for a complete TV frame of two vertical fields, and a one-hour recording will fit on a reel 10 inches in diameter.

The drawing of Figure 9 shows how the four kinds of tracks are placed on the tape.

Although quad-head machines are capable of near-perfect recordings, they are too complex, too large, and too expensive for most non-broadcast uses.

About 1960, another simpler variation of the rotating-heads principle appeared: the slant-track or helical-scan VTR.

### The Tracks of Helical Scan

A less-complicated mechanism would result from a system that recorded a complete vertical field in one pass of a head across the tape. However, that requires a much longer track than is possible with the quad system.

Long tracks were obtained by wrapping the tape at a slant around a large drum (which does not ro-

tate), and with the tape entering at a point higher or lower than where it exited. Through a horizontal slit in the drum, either one or two heads rotate at high speed in a direction opposite to the tape travel (Figure 10).

In other words, the head rotates in a circle parallel to the baseplate inside a slanted circle of tape. When on the drum, the tracks are parallel to the baseplate, but after the tape leaves the drum, the tracks are diagonal across the tape.

### Two basic types

Helical-scan VTR's usually are built in only two basic types: the half-wrap with two heads; and the full-wrap with one head (Figure 11). Even so, there's little standardization between basic models made by different manufacturers (tapes made on one model can't be played on another).

### Half-wrap type

Advantages of the half-wrap two-head types are that the finish of one track and the start of the next can be made to overlap (eliminating any drop-out time), there is less tendency for the tape to stick to the drum, and half-wrap makes possible cartridge operation.

Disadvantages include a shorter track length (possibly restricting the bandwidth), a more-complicated circuit is required because it's necessary to switch heads during playback, and problems of matching the video quality coming from the two heads.

"Skip-field" recording is a simplified form of this type. Two active heads are used with one mounted slightly higher than the other so both trace the same track of the tape. During recording, only one head is supplied with the FM signal. The active head records a magnetic track, and the other head merely moves across the same track without changing it. Both heads are used for playback. One head supplies the first vertical field, and the other furnishes video for the second field. However, the video content is the same from both heads. It's just supplied twice.

Vertical interlace is impossible



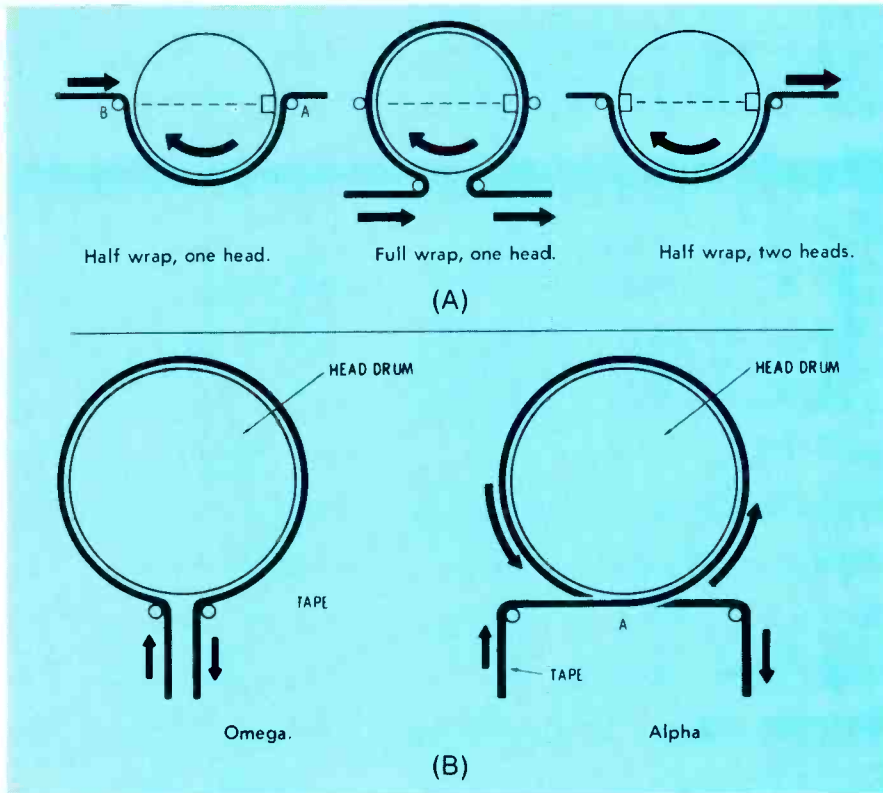

Fig. 11 Various models have different number of heads and types of tape wraps. (A) Two heads or one can be used with a half wrap of tape, or a full wrap might be used with a single head. (B) There are two kinds of full-wrap paths. The alpha more than encircles the drum, permitting less loss of signal between tracks, while the omega does not complete the circle.

with such a system, and there is some loss of detail. Many simple VTR's have random interlace, and cannot be used for TV broadcasting.

The ill-fated Cartrivision is an example of a half-wrap skip-field VTR in cartridge form.

#### Full-wrap type

Both "omega" and "alpha" kinds of complete wrap with one head have been used. The alpha type reduces the amount of signal drop-out occurring between the tracks.

Advantages of the full-wrap drum include a longer track giving a wider bandwidth, and the elimination of both the head-switching circuits and the need for matching of the heads to give the same picture quality.

The major disadvantage of full-wrap drums is "sticktion", the tendency of smooth surfaces to adhere. Wide tapes are more prone to

stick against the polished, stationary drum. Most full-wrap machines use 1" tape, while the half-wrap models have either 1/2" or 1" widths.

Of course, rotation of the head produces a breeze which reduces the pressure between drum and tape, and this minimizes the possibility of a sticking tape.

#### Video Heads

Compared to audio heads, video heads are small, consisting of a small ferrite chip only 10 mils thick, with a gap of 40 to 50 microinches, and 6 to 8 turns of wire (Figure 12). The ferrite chip is epoxied to a metal plate assembly (Figure 13), which is mounted on the rotating arm.

#### Head Synchronization

Perfect synchronism of the playback with the previously-made recording is absolutely essential. Of course, the head must trace exactly in the center of the track to avoid

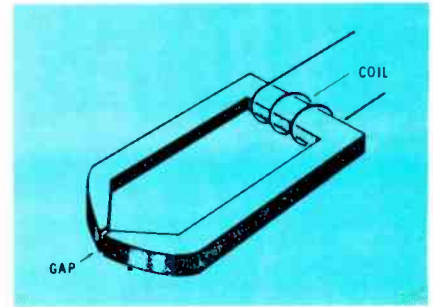

Fig. 12 Video heads have only one narrow gap in the powdered-iron core and just a few turns of wire.



Fig. 13 Each tiny video head is fastened to a plate assembly, which has provisions for electrical continuity, and for precise mechanical adjustments.

loss of amplitude. But, in addition, the head must be at the right point on the track.

The principle of synchronization by varying the speed of the capstan and the head wheel through a servo system is the same as that described for the quad-head machines, except vertical-sync lock is sufficient for helicals while quad machines in addition lock to each horizontal line. Full-wrap machines switch tracks just before or just after each vertical sync pulse, so the slight loss of signal will not be visible.

#### Recording Color TV Programs

It is possible to feed normal NTSC color video direct to the frequency modulator and record it on tape. However, beats or moire patterns frequently result. Some machines avoid this problem by moving the FM carrier to a higher frequency by means of a switch

(Continued on page 57)



Which incentive is more likely to motivate your employee or co-worker to give you the extra effort needed to make your business successful?

# How to get more work from your employees...without mutiny

By Joseph Arkin, CPA.

*During these turbulent times, it's essential for every shop owner to increase productivity of his employees. However, some methods operate in reverse. Others are ineffective. Here are suggestions to motivate your employees by proven methods.*

Bellowing, "Get the lead out!" to an employee might help relieve your feelings of frustration built up from having to deal with exasperating customers, but can such an outburst actually result in more work finished? If the "fear" approach doesn't produce the best reactions (and it doesn't), should you promise

rewards, or make appeals to his reason or sense of fair-play?

Industrial psychologists for years have studied to determine which methods worked best in motivating, instructing, or inspiring workers to increased production and higher levels of proficiency.

Test your ability to obtain more work from your employees by answering the following quiz (compiled by the American Oil Company):

**Question 1:** Will most employees work harder if you assign impossible deadlines and goals? **Yes or No?**

**Answer 1: No.** Why should anyone

knock himself out working at top speed, if he knows there is no possible way of meeting the deadline? Many employees respond with anger, feeling an injustice. Some might concentrate more on excuses and less on an all-out attempt at meeting the goal. Others become discouraged and don't try.

**Question 2:** On the average, does an employee try harder, if you let him try his own methods of doing the job? **Yes or No?**

**Answer 2: Yes.** Often two sets of ideas are better than just one. That employee might think of an innovative approach that wouldn't occur to you. If his way doesn't work out,

then he will be more inclined to use your method, knowing his idea has been given a fair trial.

**Question 3:** Is it likely a man will work harder, if you pay him more money? **Yes or No?**

**Answer 3: No.** Many studies of worker motivation revealed that salary ranked only fourth in a list of incentives. Employees first wanted fair company policies, recognition from supervisors of tasks well done, and better working conditions before higher salaries.

**Question 4:** Will a worker be certain of success if he knows you expect him to do only what he's told? **Yes or No?**

**Answer 4: No.** If he's motivated by a desire to "get ahead", an employee will do more than the minimum required of him. Let him offer suggestions, ask questions, and take on added responsibilities, if you want a valuable worker.

**Question 5:** After you have given instructions, do you ask an employee to repeat them? **Yes or No?**

**Answer 5: Yes.** When a person tries to explain your instructions, you find out in a hurry how much he actually understands. But if you merely say, "Do you understand?", he won't want to embarrass himself so he'll say "Yes", whether or not he does.

**Question 6:** If you confide in your employees that the firm is dying slowly, will they try harder? **Yes or No?**

**Answer 6: Yes.** While nobody wants to listen to prophecies of doom, people usually rally behind a good cause. There are many reasons for this. It would hurt the pride of some to be associated with a firm that failed. Others might not want the trouble of finding another job; or a few might have an unselfish desire to help the boss, when they know the danger is real.

**Question 7:** Will a person work faster, if you constantly watch him? **Yes or No?**

**Answer 7: No.** However, the answer needs some explanation. If you stand over a person with a stop watch, so to speak, he will be so conscious of your observation that it will be almost impossible for him to work efficiently, even though he might want to do so. On the other hand, genuine interest (not the smothering kind) spurs a worker on to better productivity. During

World War II, for example, some experiments were tried with a certain production line. The lighting was improved, and production increased. More comfortable chairs were provided, and production increased, again. In fact, everything tried improved productivity. The final conclusion was that **any** interest shown the people was the incentive for them to increase their efforts.

**Question 8:** Should you inspire your employees to attend technical seminars or night courses to further their education? **Yes or No?**

**Answer 8: Yes.** Especially in the electronics field, changes come so rapidly that constant study is necessary just to stay even. Hint: Why not provide each technical employee with his own subscription to **Electronic Servicing**?

**Question 9:** When an employee has a business or technical problem, should you let him solve it alone? **Yes or No?**

**Answer 9: Yes.** A good manager delegates authority. However, he must delegate to those who efficiently can take care of the prob-

lems. Strength comes only from exercise, so build up the ability of your employees by urging them to handle more of the problems.

**Question 10:** If you want someone to do you a special favor, should you remind him of helpful things you have done for him? **Yes or No?**

**Answer 10: No.** This kind of approach is like asking him to pay a debt; most people resent such pressure. On the other hand, honestly admit you need help, and it's not likely you'll be turned down.

### Score Yourself

Add your correct answers, and rate your performance according to these standards:

**10 correct:** You're a born diplomat; no one can refuse you anything.

**7 to 9 correct:** When you say, "Please", your request usually is granted.

**5 to 6 correct:** Your persuasive techniques could use some polishing.

**0 to 4 correct:** You're in trouble. Better study the quiz and practice those suggestions before you ask for a favor. □

## 20 MHz "MINI-SCOPE" ..... ON THE GO!



- Battery or AC powered
- Weighs only 5½ lbs.
- DC - 20 MHz bandwidth
- 10 mV/div sensitivity
- Rack mountable
- 100 nsec/div sweep rate
- Thousands already in use

If you need a lab quality portable scope, but don't feel like lugging the weight around—or lack the space, then consider Model PS910B. This battery operable, high performance "visual trouble-shooting tool" is a natural for servicing today's technology, at the plant or in the field. It is designed to operate from internally mounted standard "C" size battery cells, and it triggers like a lab scope. Whether you are servicing analog circuitry or digital logic, the PS910B is the "mini-scope" for you!

AVAILABLE NOW FOR ONLY **\$645**

### FITS IN A BRIEFCASE

INTERESTED? Call Hal Wardein at (714) 279-6572, or write to us at 7170 Convoy Court, San Diego, California 92111. For local ordering information, dial TOLL-FREE 800-645-9200; in N.Y. State call collect (516) 294-0990.

From a Leader in Mini-Portable Oscilloscopes

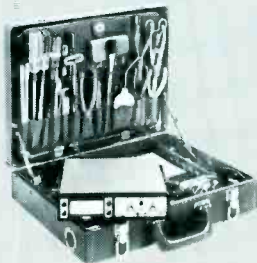

**VU-DATA  
CORPORATION**



For More Details Circle (12) on Reply Card

# A bad day at the service bench



By Robert L. Goodman, CET

*A technician with an excellent technical education, years of experience, an inquisitive mind, and fine test equipment should find defects in a hurry. Right? Not necessarily so! Sometimes a routine trouble can trip up the experts.*

One hot summer day, a friendly competitor called me and said he was unable to lick the vertical roll problem in a small-screen color receiver. He asked if I could give him any tips or hints. As we talked, I pulled the service data (Photofact 983-2) for the Zenith 15Y6C15 chassis. The circuit (Figure 1) seemed to have no unusual complications; it is a multivibrator oscillator, using the two halves of a 6MF8 tube.

This technician was an experienced old-timer, who usually was very competent with similar repairs. Therefore, I suspected some kind of odd-ball trouble. I suggested he check for leakage from vertical hold to ground (which would make the oscillator run too fast) and for any leakage between the terminals around the vertical circuit. "Okay, I'll check those out" he said, "and

if I still can't find the trouble, I'll bring it to your shop."

Evidently, the tips didn't help, because I found the receiver on my bench the next morning.

Before I list the embarrassing attempts made in searching for the defective part, let's review some of the theory and practical tests of circuits of this kind.

## Multivibrator Vertical Sweep

The plate of V6A drives the grid of V6B through C99, and the plate of V6B feeds the grid of V6A through C101, R123, C96 and R117. Therefore, the two stages make up a multivibrator oscillator. In addition, V6B is sufficiently powerful to drive the vertical yoke coils. Sync is injected at the cathode of V6A.

Sweep and linearity at the bottom

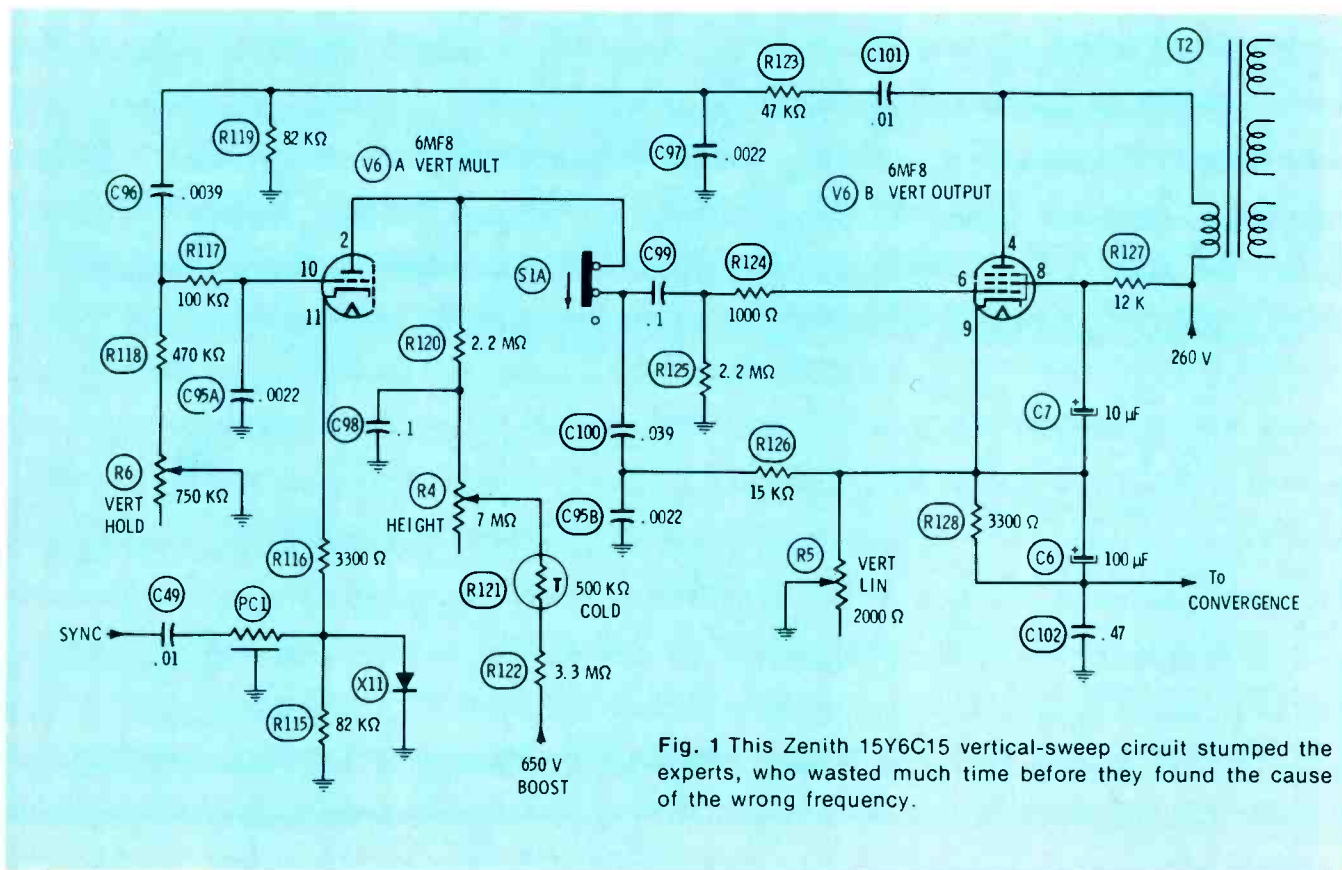
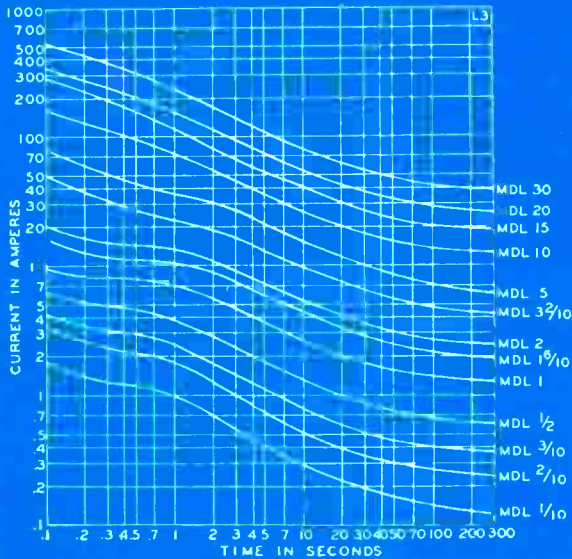

Fig. 1 This Zenith 15Y6C15 vertical-sweep circuit stumped the experts, who wasted much time before they found the cause of the wrong frequency.

# NEED A 1/4" x 1-1/4" TIME-DELAY FUSE OR QUICK-ACTING FUSE?

# BUSS HAS IT!

Time-current characteristics of FUSETRON® dual-element time-delay fuses



Time-current characteristics of BUSS® fast-acting fuses

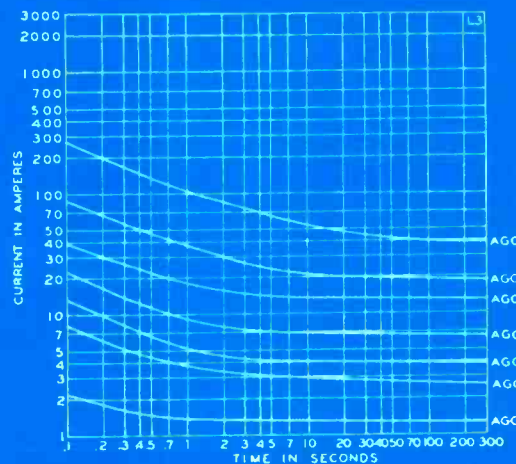

### FUSETRON® dual-element fuses

Time-delay characteristics avoid nuisance openings from starting currents or surges—yet, give full protection from short-circuits or dangerous overloads.

Voltage	Symbol	Amperes
250 or less	<b>MDL</b>	1/100, 1/32, 1/16, 1/10, 1/8, 15/100, 175/1000, 3/16, 2/10, 1/4, 3/10, 3/8, 4/10, 1/2, 6/10, 7/10, 3/4, 8/10 or 1
250 or less	<b>MDX</b>	1-1/4, 1-1/2, 1-6/10, 1-8/10 or 2
125 or less	<b>MDL</b>	1-2/10, 1-1/4, 1-1/2, 1-6/10, 2, 2-1/2, or 2-8/10
125 or less	<b>MDX</b>	3, 3-2/10, 4, 5, 6-1/4 or 7
32 or less	<b>MDL</b>	3, 3-2/10, 4, 5, 6-1/4, 8, 10, 15, 20, 25 or 30

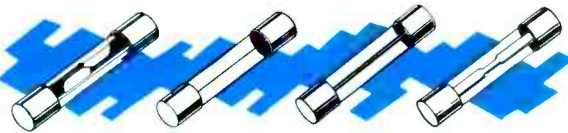

### BUSS® fast-acting fuses

Fast-acting characteristics provide the instantaneous high speed opening necessary to protect sensitive instruments or delicate apparatus.

Voltage	Symbol	Amperes
250 or less	<b>AGC</b>	1/500, 1/200, 1/100, 1/32, 1/16, 1/10, 1/8, 15/100, 175/1000, 3/16, 2/10, 1/4, 3/10, 3/8, 45/100, 1/2, 6/10, 3/4, 1, 1-1/4, 1-1/2, 1-6/10, 2
250 or less	<b>MGB</b>	1/16 or 1/8 MBW & MBB fuses now called AGC.
250 or less	<b>AGC</b>	2-1/2, 3
250 or less	<b>MTH</b>	4, 5 or 6
For 250 volt fuses above 6 amperes—See ABC fuses.		
125 or less	<b>GLH</b>	7, 8 or 10
32 or less	<b>AGC</b>	4, 5, 6, 7, 7-1/2, 8, 10, 15, 20, 25 or 30

For a complete selection of BUSS fuses and fuseholders ask for bulletin SFB.



BUSS In-the-Line Fuseholders

HKP Fuseholder

BUSS Panel Mounted Fuseholders Lamp Indicating

BUSS HGB-C Fuseholder Military Type FHL11U

BUSS Space Saver Panel Mounted Fuseholders

BUSS HMR Shielded Panel Mounted Fuseholders

BUSS Snap-Lock Rear Panel Mounted Fuseholders

BUSS Panel Mounted Fuseholder

Fuse Blocks For 1/4 x 1 1/4 Inch Fuses No. 4408 2 pole



BUSSMANN MANUFACTURING  
a McGraw-Edison Company Division  
St. Louis, Missouri 63107



of the picture is determined mainly by the values of R120, R4, R122, C100 and R126. Linearity at the top edge of the picture is affected principally by the bias of V6B; which is adjustable by the vertical linearity control, R5, and easily changed by leakage in C99, or by a gassy tube. Less cut-off bias spreads the linearity at the top.

Frequency mainly is determined by the time constant of C96 versus the values of R117, R118 and R6 hold control. Increased signal amplitude at C96 makes the oscillator run faster (raises the frequency). Also, the values of R119, C97, R123 and C101 affect the frequency to some degree.

### Testing For "No Vertical"

The following series of quick tests are designed to isolate the origin of no height:

- Connect one end of a .1-mfd capacitor to the 6.3-volt heater supply, and attach a clip lead to the other end;
- While watching the horizontal line on the screen, touch the clip lead to the plate of the vertical output tube. A one-time downward "blink" of the line proves the yoke and output transformer probably are okay, and that the tube has plate voltage. (The quick movement of the line is caused by charging of the test capacitor, and will not be repeated unless you disconnect and

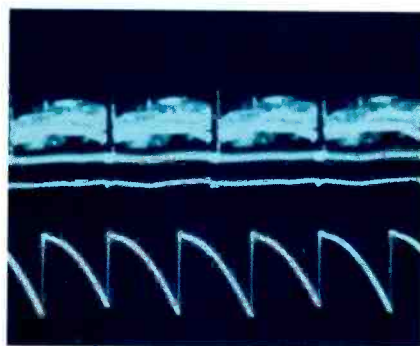

A1

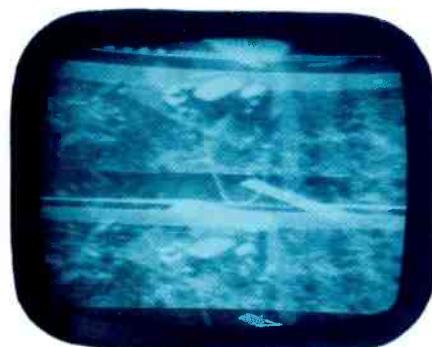

A2

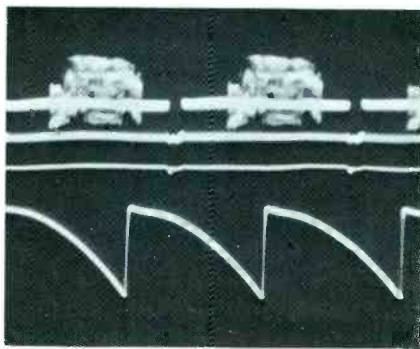

B1



B2

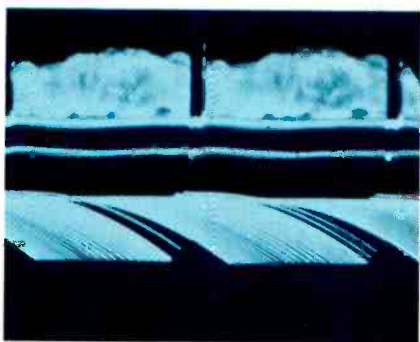

C1



C2

**Fig. 2** These are comparisons of dual-trace scope waveforms of different vertical sweep frequencies with the TV pictures that result. Positive identification of frequency is possible by adjustment of the vertical hold control so that both video and sweep traces are motionless. Then the ratio of the cycles of video to the cycles of vertical sweep can be solved to give the frequency. All except two of these examples are "locked", but only one is locked correctly. Notice that few of the TV pictures can be used to prove

the actual frequency. **A.** The sync in alternate video fields locks every third cycle of vertical sweep (lower trace), a ratio of 2-to-3, or a vertical frequency of 90 Hz. Both traces and the picture are motionless, indicating locking. However, the lack of a 1-to-1 ratio and the appearance of several overlapping TV pictures shows it to be false locking. **B.** A ratio of 1½-to-2 (3-to-4 is easier to handle) shows the sweep frequency is 80 Hz. There's no distinctive difference between this TV picture and the previous one at 90 Hz. Only

the scope waveforms offer accuracy. **C.** Slow drifting of the sweep waveform to the left and a slow downward roll of the TV picture indicate the vertical frequency is slightly too fast, perhaps around 65 Hz. This is one of the few times the picture is useful in determining the frequency. **D.** At last, correct locking. A 1-to-1 ratio of the cycles of waveforms and a motionless single TV picture both prove it. Sweep frequency is 59.95 Hz, called 60 Hz for convenience. **E.** Neither the sweep waveform nor the TV picture is locked,

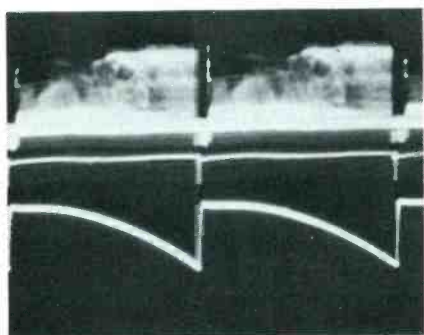

D1



D2

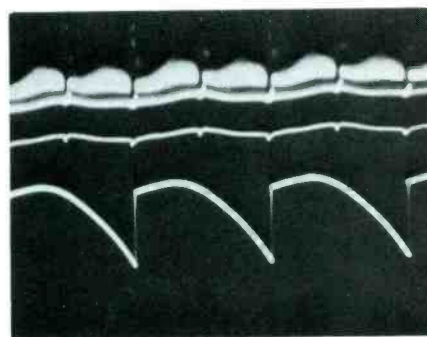

G1

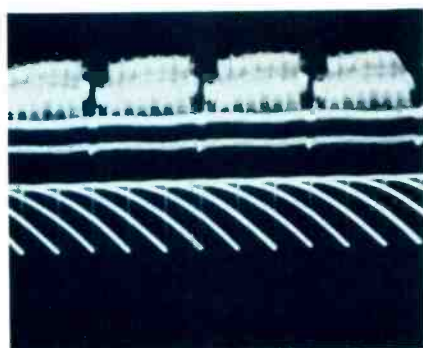

E1



E2

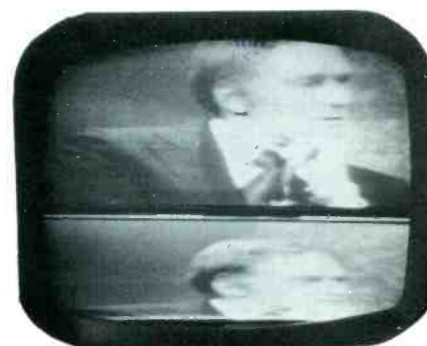

G2

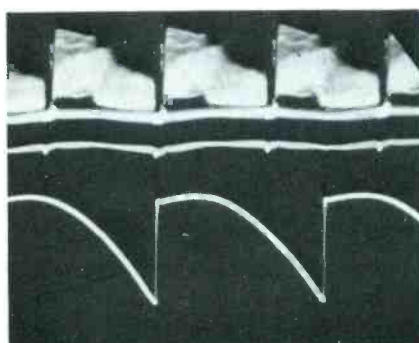

F1



F2

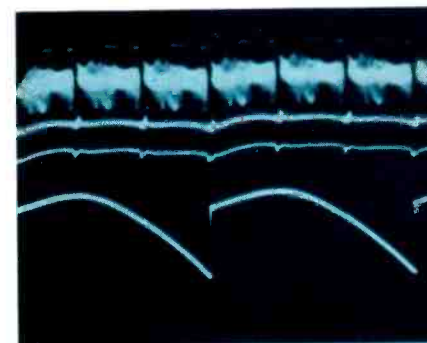

H1

and neither gives much of a hint about the frequency. However, I know by the position of the vertical-hold knob that the frequency is too low, perhaps around 50 to 55 Hz. F. Ratio of video to sweep is  $1\frac{1}{2}$ -to-1 (3-to-2), so the sweep frequency is 40 Hz, although it can't be proved from the TV picture. G. Two cycles of video to one of sweep prove the vertical is running at 30 Hz, just half the correct frequency. The TV picture has two complete scenes with a blanking bar in between. Except for linearity compression at the bottom of the lower pic-

ture, the two are identical. Frequency can be proved by the picture, in this case. One of the capacitor values had to be increased to operate the sweep at such a low frequency. H. Three fields of video to each cycle of sweep show a 3-to-1 ratio, for a sweep frequency of 20 Hz. Appearance of the TV picture was similar to that of the 30 Hz one, except for foldover of nearly the complete third picture at the bottom. Again, I changed the value of a capacitor to obtain these pictures. I have never seen this condition happen because of natural defects.



H2

short out the capacitor before making the test again);

- Connect the clip lead to the grid of V6B, the output tube. About four or five inches of sine-wave deflection should result. If not, V6B, or some component in the cathode circuit, is defective;

- Connect the clip lead to the plate of V6A, the "oscillator". Deflection should be about the same as during the previous step. If not, examine the Service/Normal switch (S1A), and test C99;

- Connect the clip lead to the grid of the oscillator. Almost full height should be obtained, with the picture slowly moving downward. If no deflection results, V6A and the plate components should be tested;
- Unsolder C96 at the R119 end, and connect the clip lead to the loose end. Again, almost full height should result. If not, C96 is open. (One variation of this test is to grasp the loose end of C96 with the fingers. Some deflection should appear, the exact amount depends on the amplitude of stray 60 Hz picked up by body capacitance.)

These previous steps check both stages as if they were amplifiers. If the test results were as expected, but there was no height when the circuit was hooked up in the original way, some defect is indicated in the positive-feedback network. R123 or C101 might be open, or C97 could be shorted.

### Sync Diode Problems

Diode X11 is a gate intended to short out noise or spurious signals during the conduction time of V6A, and to be an open circuit to the negative-going sync signal, allowing it to reach the cathode.

If X11 shorts, there will be no locking. However, an open X11 produces a decrease of height.

### Decreased Height Problems

Other than weak tubes, the most likely causes of reduced vertical height are increased values of R120, R4, R121 or R122. Traditionally, an open cathode capacitor eliminates the lower one-third of the picture. C6 functions as the cathode bypass here, but it returns to ground through the convergence assembly. More about that later. In addition, an open C7, screen bypass, reduces the height.

One unusual feature is the **two** DC paths from the cathode of V6B to ground. This can cause some unique symptoms. One path is through R128 (which is paralleled by C6) and the vertical-convergence circuit to ground. The condition of C102 can affect the convergence, but not the height. Resistance of the convergence is low; therefore, C6 acts as any other cathode bypass, producing a loss of some height when it is open.

Operation with the convergence cable unplugged gives the same loss of height as an open C6. If you want to operate the chassis without the convergence harness, connect a 100-ohm 1-watt resistor from the negative side of C6 to ground.

An open R128 would reduce the height, which probably could be restored by a readjustment of R5. The loss of DC path would allow the center convergence to wander a bit more than usual.

If the vertical linearity control (R5) opened, the linearity at the top would be compressed, and the height would be reduced.

In the unlikely event that both R5 and R128 opened, a peculiar symptom might occur—"pumping". In other words, the vertical sweep continues for a fraction of a second, then collapses to a horizontal line, builds up to nearly full scan, and collapses again, over and over. The effect is due to charging and discharging of C6 from the current of V6B when there is no DC path to ground. The first time it happens to you, the solution is likely to be difficult.

### Vertical Does Not Lock

Now, back to my original vertical-roll problem.

Two different general conditions can prevent locking of the vertical sweep. One is a lack of sufficient vertical sync. The picture can be made to spin either upward or downward, but won't hold still. The other extreme is plenty of vertical sync, but the oscillator cannot be adjusted to the correct frequency. Therefore, true locking is not possible.

In this case, adjustment of the vertical hold control would change the appearance of the many pictures on the screen, but could not reduce them to just one complete picture. It was evident, the fre-

quency was wrong.

Preliminary tests of resistances and DC voltages failed to discover any defects. A component-substitution box was used to sub temporarily the most-likely parts. No improvement was noted. Next, exact-value components were installed in place of the prime suspects. These included the vertical hold control, R118, R117, C96, C95A, C99 and C101; but locking still could not be obtained.

In desperation, I removed the tube and checked both grid circuits to see if board leakage might be upsetting the biases. Results indicated no leakage. I tried another leakage test by using a scope connected to terminal pins **next** to those of the vertical circuit. Again, no proof of leakage.

### What Was The Frequency?

Sometimes it is very helpful to know the actual frequency. Defects causing fast frequencies are ordinarily just the opposite of those producing slow frequencies. Analysis gets a little involved, so it's used only as a last resort.

To find the vertical scanning frequency, I chose my favorite dual-trace scope. Low-cap probe of channel 1 went to the negative-going video signal, and the other probe to the cathode of V6B.

It's not discussed often, but true phase relationships between two signals viewed on dual-trace (time-sharing) scopes can be assured **only** if the scope is locked to just **one** of the channels, or to an external sync signal. I used the built-in sync separator of the scope, and obtained the vertical sync signal from the video of channel 1.

Most technicians know that we can turn a vertical hold control beyond the correct point (which gives just one locked picture) and find one or more additional positions where the picture seems to stop spinning, but with several pictures offset vertically. This is the condition I call "false" locking. For example, alternate sync pulses might be locking with every third sweep cycle.

Rather than merely show you the picture and scope pattern I obtained with this Zenith, I later made up a complete set of all false locking conditions (see Figure 2). Refer to them for help with your



vertical problems.

The scope waveforms proved the TV vertical locked to 40 Hz with the hold control about mid-range. It could be made to lock at 30 Hz, but not at the correct 60 Hz. This information was very interesting; however, I already had replaced the components most likely to make the vertical run slowly!

### Expert Number Three

Luckily, the Zenith Field Representative was in town for a technical meeting, and he dropped by my shop to discuss electronic problems. Of course, I dumped this "dog" on his back; so to speak.

He went through about the same tests as I had performed already, and with no more success.

Just as I was replacing C101 for the fourth time, the truth hit us both simultaneously. What was the schematic value of C101? Why, .01, of course. And what size had been in the circuit four times? None other than a .1! How could three sharp technicians have made such a mistake? Well, C99 which is a .1 is located close to C101 on both the chassis and the schematic. Somehow they had gotten mixed up in our minds.

### Moral

The moral of this true story is obvious: use only the correct size of replacement parts. Of course, we all know this already, but a reminder might be helpful. These little human "glitches", along with FCC and CET tests function to keep us humble. □

What would  
you like  
to read  
in ES?  
Send in  
your ideas.

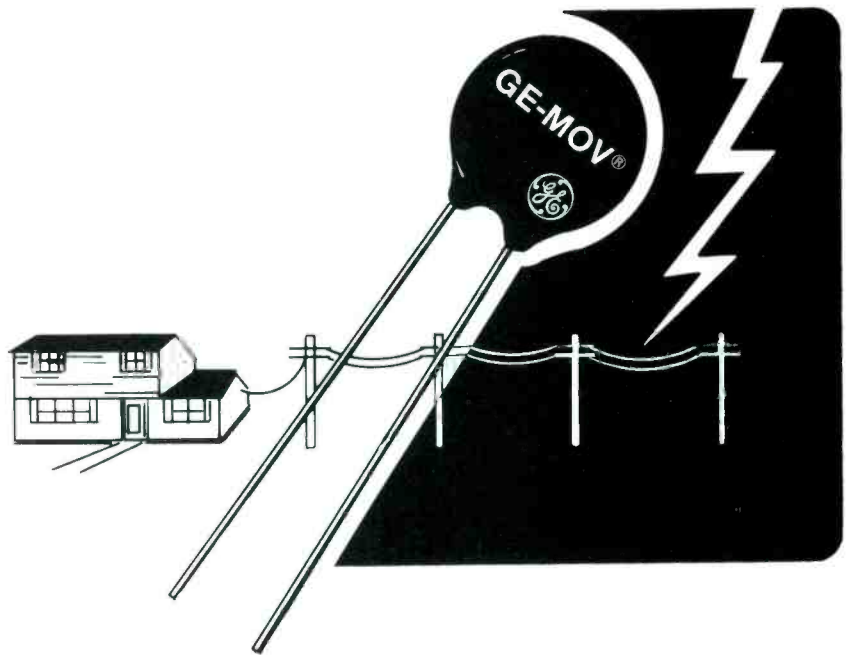

## NOW! Protect against Transient Voltage Damage to TV, Stereo and Home Appliances with GE-MOV<sup>®</sup> Metal Oxide Varistors.

TV Set manufacturers know that between 50 and 70% of all warranty failures are caused by voltage transients: lightning, voltage spikes and power surges. Now you can do something about it . . . economically.

Insert easy to install GE-MOV metal oxide varistors in component circuits and prevent damage from transient voltage once and for all. The varistor absorbs the dangerous transient and dissipates it as heat. The cost is low. The installation fast and easy. It's like offering your customers an insurance package . . . and it's an opportunity to make a profit!

Our GE-MOV program is ready and waiting. For all the facts about this addition to General Electric's growing replacement semiconductor line, see your authorized distributor.



TUBE PRODUCTS DEPARTMENT  
GENERAL ELECTRIC COMPANY  
OWENSBORO, KENTUCKY 42301

GENERAL  ELECTRIC

# Profitable MATV repairs

By Jim Kluge

Technical Editor Winegard Company

TEST MATV  
THIS WAY

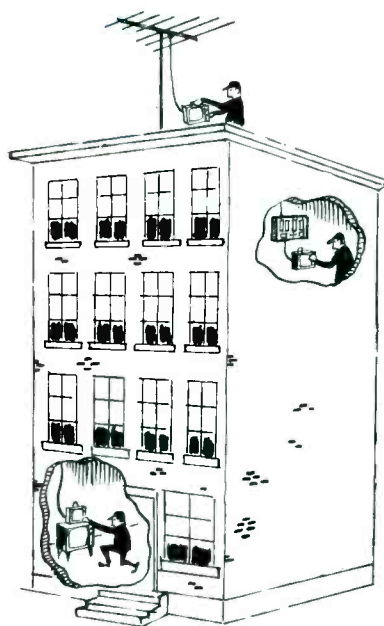

NOT  
THIS WAY



*It has been estimated that more than 90 percent of the MATV systems are not operating properly. Perhaps one channel has good reception, but the others might have snow, sync compression, smear, or "windshield wiper" interference. You can make money repairing or redesigning such systems. Here are some suggestions to guide you.*

## MATV Repairs Are Different

In addition to specialized tools and techniques, MATV repairing is different in at least three basic ways from TV servicing.

Most MATV work must be done at the job site. Of course, individual amplifiers or other small units can be brought to the shop. However, the antennas and wiring must be checked or repaired where they are installed.

You will be under more pressure to produce superior results. For example, the owner or manager of an apartment house where the MATV system cost around \$5,000 is not going to be satisfied with pictures of "rabbit-ears" quality.

If a TV receiver has been operating for a year or more without any problems, we can assume safely that any trouble symptoms are due to defective components, and that the wiring and parts originally were in perfect condition. MATV performance can't be assumed so easily. The performance might have been sub-standard from the beginning. In that case, you must determine if the design was faulty, if the components were installed incorrectly, or if the components are of inferior quality.

**The odds are high that you will find far more systems needing redesign or better components than**

**those requiring only a simple parts replacement.**

## Trouble At One Tap

If the complaint implies that only one receiver has a signal problem, assume it's true. But remember one whole branch (or even the entire system) might be out of order, and this could be just the first of many reports.

## Receiver or signal?

Try the reception on every active channel, but don't touch the cable or move the TV receiver until afterwards. The tap or the coax might be intermittent, and you need all the clues possible.

At this point, **the most helpful item of test equipment is a portable color TV in good condition.** You should bring one on all MATV calls. Disconnect the matching transformer from the TV receiver and transfer the leads to your test receiver. If the reception is noticeably better, the customer's TV is malfunctioning. **Many arguments and disagreements can be prevented by showing the tenant or manager the difference of reception.**

Of course, if the quality of picture is about the same on both receivers, the trouble is in the MATV system.

## Why a color set?

Perhaps you wonder if a small-screen b-w TV receiver would be just as satisfactory as a larger color portable. The answer is a resounding "No!" Most b-w sets have an IF bandwidth about half as wide as those in color TV's. Smaller screens obscure any smear, ringing or snow, so the pictures look cleaner than those on larger screens. Color receivers **must** be fine-tuned correctly, but b-w tuning can be offset to minimize some

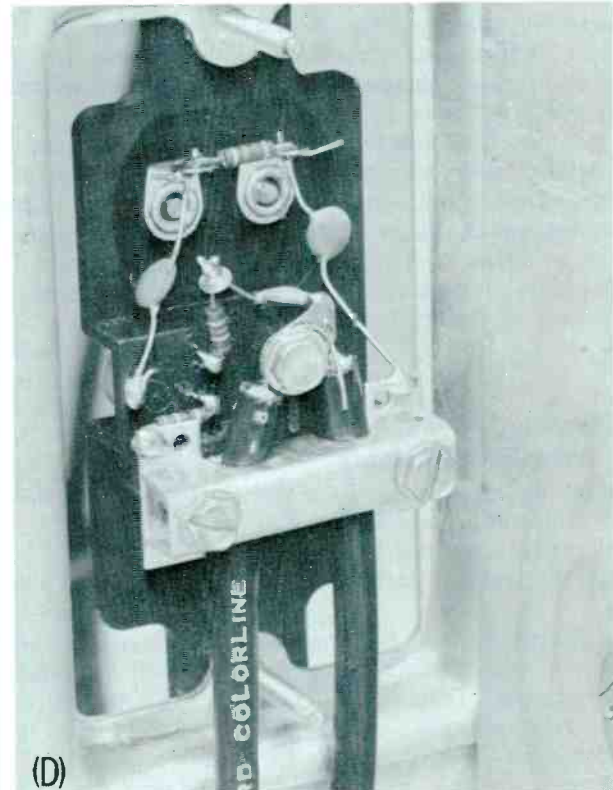
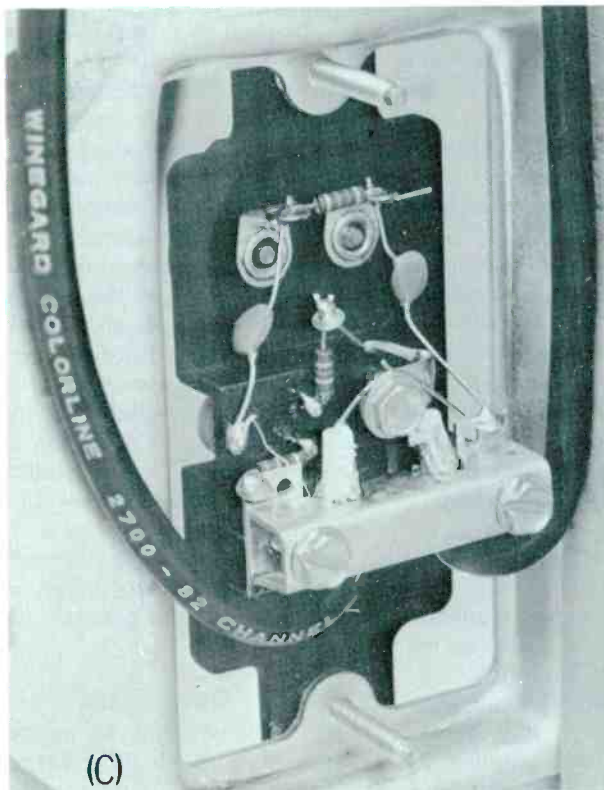
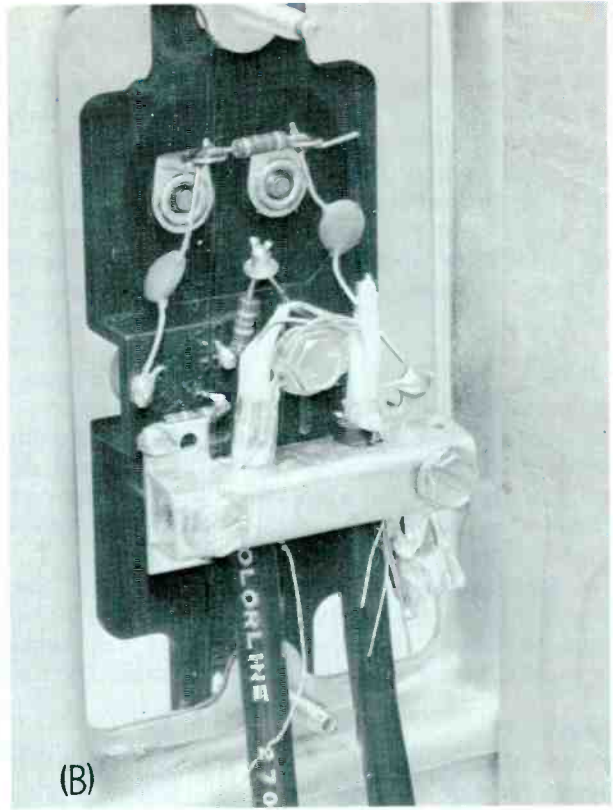

**Fig. 1** These are three examples of poor workmanship in the wiring of an MATV tapoff, plus one example of good practice. (A) This can be your standard of correct wiring. Both center conductors are under the screw head and the excess has been cut. Sections of the shields have been twisted and located under the ground clamp. The amount of stripping and the location of the cables are good. (B) One of the center conductors is not under the screw head, and the

other is shorted to the exposed foil. Stripping has been done carelessly. (C) Both cables have sharp bends, and one of the center conductors extends too far from the screw head, possibly shorting to the ground. (D) The shield has been stripped too close to the screw head, and the shield wires have not been placed under the clamp, possibly causing a poor ground.

kinds of interference. It's possible for an antenna-system defect to wipe out the color from one channel, while permitting normal reception on the others. A b-w receiver used to test picture quality can tell you some things, but a color set is far superior for this purpose.

#### Cable or tap?

Next, substitute your test cable. This wall-to-set cable should have the proper coax connector on one end and a matching transformer on the other. Also, cables for other variations should be handy; such items as coax-to-coax for sets with 75-ohm inputs, or cables for any non-standard taps. Improved reception means the old cable is bad.

#### Tap or system?

You can waste a lot of time if you dissect the tap and associated wiring before finding the defect is far away in another end of the system. Therefore, check the reception in other apartments nearby. If other receivers are showing good pictures, then carefully check this one tap and wiring. Some examples of good and slipshod tap connections are shown in Figure 1.

If the problem doesn't originate in that one tap, check the signal at the antenna, or the head end, if one is used.

### Checking Antenna And Head-End Problems

Ask the building owner or manager for the drawing of the MATV system, and use it to guide you to the major parts of the system.

Find the point where the antenna lead-in joins the distributing system or the head-end. Disconnect it and look at the signals, using the portable color receiver. If the signals are poor, look for trouble in the antenna, antenna preamp, lead-in or preamp power supply. A windstorm or a careless workman on the roof might have changed the orientation or caused damage.

Most problems, however, show up in the distribution system. If the picture quality of the signal from the antenna is good, then

connect the output of the head-end through a suitable attenuator to the test TV.

Be sure when you're comparing the pictures on all channels that the same approximate signal levels are applied to the television. Typically, levels at the output of head-ends are 50 dBmV to 60 dBmV. That's enough to overload most TV sets, if applied without 50 to 60 dB of attenuation.

**Picture quality at the output of the head-end should be as good as that coming from the antenna.** If not, something's wrong with the head-end.

Whenever you find a malfunction, fix it before you proceed. Then test again for additional troubles; there may be several.

### Distribution Problems

Suppose the signal was fine at the output of the head-end, but was very poor at the customer's tap. Obviously, the defect is in between those points; but how do you find it?

Refer to the "as-built" drawing of the system to determine if there are several branches coming from splitters or just one line.

If the system has several branches, check the levels and signal quality in each leg. Splitters have a fair amount of isolation between outputs; therefore, defects in one branch usually have no significant effect on the others. **Find the branch with the worst signal; it's probably the one with the defect.**

#### A short is not a short

Don't expect this radio-frequency (RF) wiring to obey the rules as we learned them for DC circuits.

As a test, I connected a test lead that had clips at each end across the terminals of a tap (similar to the ones in Figure 1). The test lead was only about a foot long, and we logically would expect such a "short" to eliminate most of the signal. But, nothing much happened! However, when I shorted the terminals together with a screwdriver blade, a faint picture could be seen through heavy snow. You can try the same test for yourself by

using the 300-ohm antenna terminals at the back of almost any TV receiver. The effect seems to be due to a combination of DC resistance and self-inductance of the short path.

#### A cable can be a trap

Coax cable is a type of tuned transmission line. As a demonstration, take a piece of cable, connect one end to an RF generator, and short together the conductors at the far end. Measure the signal amplitude at the generator as you tune it, and you'll find the cable acting as an open circuit except for a narrow band of frequencies where the short appears to be across the generator output. In other words, the short appears to have been moved from one point of the cable to another. The exact point depends on frequency.

Either 300-ohm or 75-ohm cable can be used as a trap by connecting one end in parallel with a downlead or distributing cable of similar construction, and selecting the proper length according to whether the far end is shorted or open.

It is not our purpose to give details about this use of cable. The point is that **shorts and opens in cables and taps of the distributing system often act as accidental traps** to cause a bewildering array of symptoms that almost defy logical analysis. Color might be missing from a certain TV signal at one tap, but normal at the others. Or some TV channels might be weak at a few receivers and not at others.

There's no magic formula for locating such defects. But, we can offer some helpful general tips.

#### Open Cable

An open between the tap you are testing and the head-end probably would eliminate most signals. At least, the signals would be weakened greatly, depending on the amount of stray capacity across the break.

If the open is downstream from you, the line would not be terminated properly, so the pictures should be smeared by standing waves that sometimes appear as

# Why You Should Buy Telequipment...

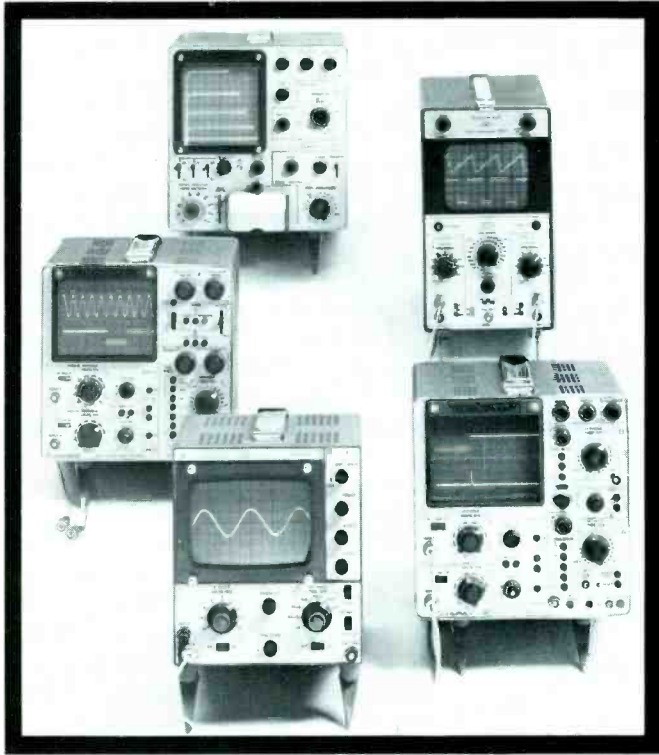

Telequipment instruments can be your best buy for trouble-shooting consumer electronic products at the bench or in the field, for many laboratory applications, for manufacturing production control, for student labs, and for broad areas of design engineering—virtually any price-sensitive area of application where the instrument specifications meet user demands. The performance and reliability of Telequipment instruments are well established.

The D61 10-MHz dual-trace oscilloscope, for example, has been acclaimed by independent experts for its "unique features and superior performance." (Use the coupon for a copy of the article, *Reports from the Test Lab.*) The D61 is chosen as a quality 10-MHz dual-channel oscilloscope throughout the industry. TV line or frame triggering and provisions for X-Y vector patterns make the D61 especially well suited to consumer product ser-

vice shops. Its stable triggering characteristics, front panel simplicity, and versatility make it an excellent choice for industrial and educational use, as well.

The Telequipment line also includes the DM64 10-MHz dual-channel storage oscilloscope, the exceptionally low-priced S51B 3-MHz oscilloscope, and more. There's an easy-to-operate transistor curve tracer, the CT71, that has wide application in schools and design labs.

loscope. (Ask for the D67 article reprint, *Another Step Forward.*) Its sister scope, the D66, offers all features but delayed sweep at an even lower price. Both feature a SUM mode with normal/invert capability that improves visibility of small signals in the presence of common mode noise.

Tektronix supports Telequipment with its full corporate services and network of field engineers, providing complete specifications, applications notes, consultation and demonstrations, and warranty. Consider the prices as well...



The D67 oscilloscope combines dual trace, 25-MHz bandwidth, FET inputs, regulated power supplies, and all solid-state circuits with delayed sweep capability—a combination of features seldom found in such a low-priced oscil-

Model	Features	Price
<b>S51B</b>	3 MHz, Single-Channel	\$ 325
<b>D61</b>	10 MHz, Dual-Channel with X-Y	545
<b>CT71</b>	Curve Tracer	895
<b>D66</b>	25 MHz, Dual-Channel	875
<b>D67</b>	25 MHz Dual-Channel, Delayed Sweep	1,125
<b>DM64</b>	10 MHz, Dual-Channel, Storage	1,195

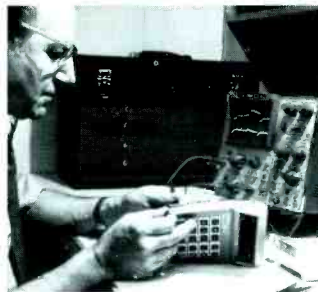

There are many good reasons why you should buy Telequipment—some general, some specific. To learn more, contact your local Tektronix Field Engineer or write Tektronix, Inc., P.O. Box 500, Beaverton, Oregon 97077. In Europe, write Tektronix Ltd., P.O. Box 36, St. Peter Port, Guernsey, Channel Islands.

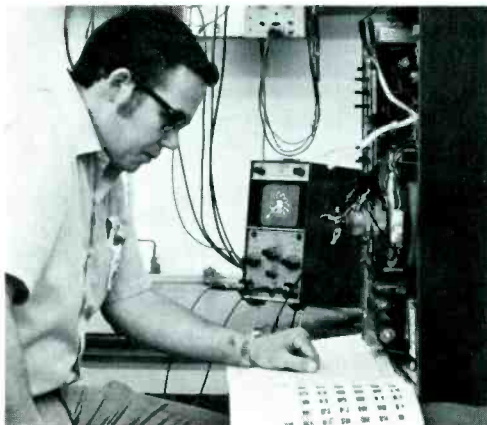

## I want to learn more about Telequipment instruments:

Name \_\_\_\_\_ Title \_\_\_\_\_

Company \_\_\_\_\_

Address \_\_\_\_\_

City \_\_\_\_\_ State \_\_\_\_\_ Zip \_\_\_\_\_

- I would like the full specifications on Telequipment instruments.  
 I want a demonstration of \_\_\_\_\_, so have a Tektronix Field Engineer contact me.

I want the independent magazine article reprint on the  D61  D67.

ES/12/74



many ghosts. Test by terminating the cable at that tap; an improvement of sharpness indicates such an open circuit.

### Finding Shorts

A short of extremely-low impedance in the cable or at a tap probably would wipe out most signals in that branch. If the cable length is long, the signal amplitude would be weak at the head-end or splitter and would become progressively weaker nearer the short. Beyond the short, the signal would be missing. Notice that this action is different from the results of a shorted cable used as a trap, because the signal is taken from a different point.

Not all shorts have such low impedance. In some cases, the short has enough inductive reactance that it doesn't kill the signals.

Instead, the picture quality is degraded.

### Ohmmeter Tests

Before you attempt to use an ohmmeter to test for opens and shorts in an MATV system, you must realize the basic types of circuits and the correct kind of taps and termination for each.

#### Direct wiring

Many of the older systems and some simple new systems have DC continuity through the entire wiring. There are no blocking capacitors anywhere. A normal ohmmeter reading across such a system would be about 100 ohms (75 ohms for the terminating resistance, plus the DC resistance of the wire).

It's easy to check for opens and

shorts using an ohmmeter. However, there are dangers of damages or shock hazards if AC enters the system, perhaps because of a defective receiver.

#### Systems with power voltage

Some large MATV systems (and CATV systems) connect either AC or DC voltage to the same cables that carry the TV signals. A voltage of this kind provides power for line amplifiers and powered splitters. Obviously, RF chokes and coupling capacitors must be used to keep power and signal voltages separated. Ohmmeter measurements across the cable terminals with power off would show only the resistances of the power source paralleled by the amplifier power supplies. You should expect a reading of several thousand ohms, instead of 75 ohms (for the direct-wiring type).

**In systems with power voltages, tests for shorts or opens are performed most accurately and speedily by the presence or absence of the AC or DC power voltages, rather than by measuring resistances or analyzing the amplitude or quality of the TV signals.**

#### Hybrid systems

Logical troubleshooting with an ohmmeter virtually is impossible in systems having a mixture of components, some of which have DC continuity, and others that have blocking capacitors.

The trend seems to be towards wall taps, splitters and terminators with blocking capacitors built-in, because they can be used in any kind of system. You must know which is which, if you intend to test them.

### Problems of Bargain Cable

Coax cable appears to be constructed very simply. A center wire is surrounded by a non-conductor to prevent shorts with the shield, and an insulating substance is placed over the shield. It seems logical that good results would be automatic, just so long as there are no shorts or opens. **Not so!**

The catch is that the cable must have a characteristic impedance,



Fig. 2 The Model FS-780 from Winegard is a tuned signal-level voltmeter for both VHF and UHF signals; one having high accuracy of readings.

and when the end is loaded with a non-inductive resistance of that value, the bounce of signal back towards the source is minimized and the frequency response is smooth and predictable.

Many factors operate to increase or decrease this characteristic impedance. Some of them are the size of the center conductor, the type of insulation and the spacing between wire and shield. These are determined by the manufacturer during the design stage, and need not concern us.

However, the variations that can and do take place during manufacturing are important to the performance of a MATV system. Perhaps the most common defect is for the wire to wander off center for several feet. Or the shield might have a wrong diameter during part of the run. Such things are called "periodic dimensional defects", and they can be real mischief-makers. They can't be found by resistance or capacitance tests.

Cable defects of this kind might cause poor reception of one channel, without affecting the others. That's because the defects produce "suck-outs"; that is, certain frequencies with loss of amplitude, very similar to the effects of traps.

The only way to verify the performance is by a sweep-frequency test of the wavelengths to be covered. Equipment for the sweep tests normally would be found only in a manufacturer's plant.

Cable not passing the manufacturer's VHF sweep test often finds its way **unmarked** to the surplus and bargain market. Beware of "seconds" or "bargains" in cable. **Suspect the cable if unlabeled cable is found in a problem MATV system which has no apparent defects.**

Because you can't go beyond an ohmmeter test of the cable, there is no other solution where the tests and symptoms indicate cable trouble except a wholesale replacement of the cable.

### Inspect the System

If your visual examination shows good-quality materials were used, but the workmanship is poor, it will pay to go over the whole system, component-by-component and tap-by-tap, inspecting and redoing bad cable connections and installations.

Then check the signal levels at the last tap in each trunk or feeder line. You should measure at least 1000 microvolts on each picture carrier at these taps. Also, the channels should be balanced to within a few decibels of each other. If not, it's time to check the design of the system.

Many MATV systems never were designed correctly. They couldn't possibly work even with best-quality components and top-quality workmanship.

### Check the design

The best way to check the design of an MATV system you're servicing is to sketch the layout. Calculate the voltage levels of signal at each tap, splitter, amplifier, etc. Then check the signal levels against the calculations. Correct any discrepancies before you move to the next point.

### Signal-level meter

Before you start servicing MATV systems, obtain a good-quality signal-level meter (commonly called field-strength meter). No one can guess signal voltages any better than he can guess DC voltages; **you must measure to know.**

Most MATV manufacturers offer such instruments. However, some low-priced ones might not do the job right. It's best to spend a bit more and have an instrument that will be completely useful. A good meter (Figure 2) will pay for itself in time saved.

In addition to being indispensable for doing MATV installation and repair work, a signal-level meter also can be used for making antenna surveys, tracing interfering signals, adjusting traps, measuring amplifier output signals, and setting tap isolation.

Another extremely-useful instrument is a spectrum analyst, which emits a continuous wide-band signal covering the entire VHF band. Such a signal applied to the head-end enables you to use a signal-level meter to detect and locate shorts, opens, suck-outs in the cable, and measure return loss. It even permits checking the calibrations of the signal-level meter.

### Losses

An understanding of system losses is essential for both designing

and repairing of MATV systems. Losses are of two types: those necessary as a trade-off to obtain another benefit; and those occurring because practical components are not 100% efficient. Let's look at some examples.

### Cable loss

Cable loss is the decrease of voltage when a signal travels through a length of coax cable. The amount of loss depends on the length of cable (longer cables have more loss), and on the frequency. More attenuation occurs at the higher frequencies, and this often is corrected by an amplifier response "tilted" to favor the high frequencies. When a line is properly terminated, the falling response is smooth and predictable.

### Splitter loss

Obviously, a signal can't be divided into two or more paths without each receiving less power. That's splitter loss, the price paid to obtain several branches.

### Feedthrough loss

Insertion (feedthrough) loss occurs when a signal passes through a component inserted in series with the line; for example, a tap-off. Such loss is not desired, but is unavoidable.

### Isolation loss

Ideally, each TV receiver should be completely isolated from the trunk line. This would prevent tuning effects from bothering other TV's.

I'll never forget the time a retail dealer had four color sets connected to the same 300-ohm downlead. All were paralleled, with no isolation between them. Often, a rotation of one channel selector would eliminate the color from another picture. That's an extreme example of what insufficient isolation can do.

In a simple resistive tap-off, increased loss brings better isolation. Of course, too much isolation/attenuation would deprive the receiver of a signal strong enough to minimize the internal snow. Therefore, a compromise is necessary.

**A better solution is available at a price. And that is to use directional tapoffs which pass more**

signal to the set and less from the receiver back to the trunk line.

### Become An MATV Designer

The best troubleshooter of MATV problems is a technician who has studied the designing of MATV systems and who also knows good techniques for troubleshooting.

Several manufacturers of MATV equipment, including the Winegard Company, regularly conduct seminars about the design and installation of home and commercial MATV systems. The seminars are held at the various home offices and selected cities around the country. A nominal fee is charged to cover part of the expenses.

If you are interested in attending such seminars, write to one or all of the MATV manufacturers who advertise in **Electronic Servicing**, asking for information. They will be happy to oblige.

### Summary

Here is a handy checklist for

troubleshooting a malfunctioning MATV system:

- Use a portable color receiver to prove whether the trouble is in the customer's receiver or in the MATV system;
- Check the wiring from tapoff to receiver, or temporarily install a test cable;
- Examine the signal strength and picture quality of each active TV channel at the antenna and head end;
- Measure signal strength at the last tapoff of each branch;
- Narrow down the area where the defect exists, then use voltage, ohmmeter, and visual tests to find the source of the problem.

If a wrong condition is found at any step of the testing, make necessary repairs before you go on. Of course, stop whenever the defect is found.

Occasionally, you will find a cable chewed by the customer's puppy, a dead amplifier, a frayed connection in a tapoff causing a short, or some other single minor

defect. But don't be surprised if either the quality of the components or the design of the system (or both!) are totally inadequate. Then your opportunity becomes greater.

### Recommend changes

Contact the owner or manager and give a preliminary report of your findings about the shortcomings of the system. After he recovers from the initial shock, ask permission to examine the system in more detail and submit an estimate of the changes necessary to insure good performance of all TV channels.

Before you go back (don't just phone) a few days later, be positive of your facts and prices. This time the owner will be more careful, because of the previous failure, and you need to inspire confidence in your knowledge and ability. **MATV systems can and should be made to operate correctly, and you are just the one to do it!** □

# // New generation // Flat rate pricing...

...truly outdates old methods ... prices your work realistically!

Still using the old single flat rate charge for house calls or bench work regardless of repair time required? You may say it all averages out. But, how strongly do your customers feel about consumerism and TV exposés? You could be leaving yourself wide open for trouble...big trouble!

This is where **Tech's Guide to Pricing** comes in ... the "New Generation" of flat rate pricing ... the system that breaks down each repair step or adjustment encountered. Keeps a true and proper balance between cost and work performed in the eyes of the consumer.

**Tech's Guide** is in a professional, hard-use cover. 6-ring steel binding, fast-tab design, 7½x9½ size fits in the tool box ... ready for immediate use. Calculator adjusts in seconds for any area in the U.S. ... it's the new industry standard. Relieves you of the stress and pressure of pricing responsibility! Simply fill out the coupon, include check or money order. All orders filled same day.

**sperry tech inc.**  
P.O. Box 5234  
Lincoln, NE. 68505

More information please.  
 My check or money order enclosed.

NAME \_\_\_\_\_  
COMPANY \_\_\_\_\_  
ADDRESS \_\_\_\_\_  
CITY \_\_\_\_\_ STATE \_\_\_\_\_ ZIP \_\_\_\_\_

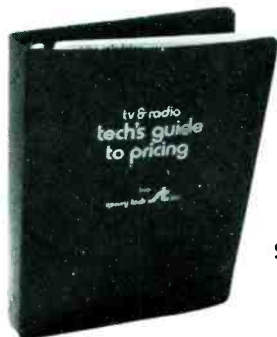

**\$18<sup>00</sup>**  
per issue,  
postpaid.

(Nebr. residents add city and state sales tax)



tv & radio  
**tech's guide  
to pricing**

For More Details Circle (14) on Reply Card



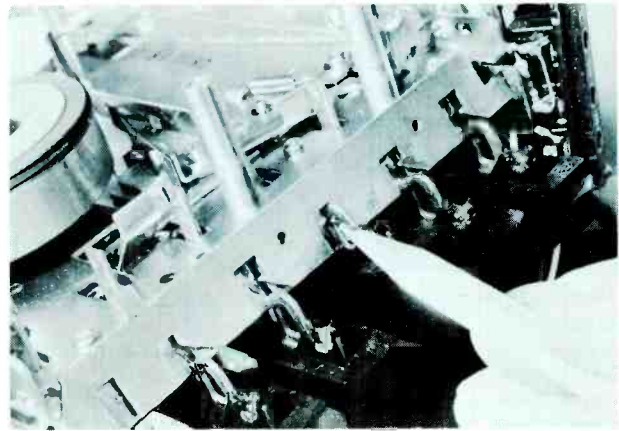
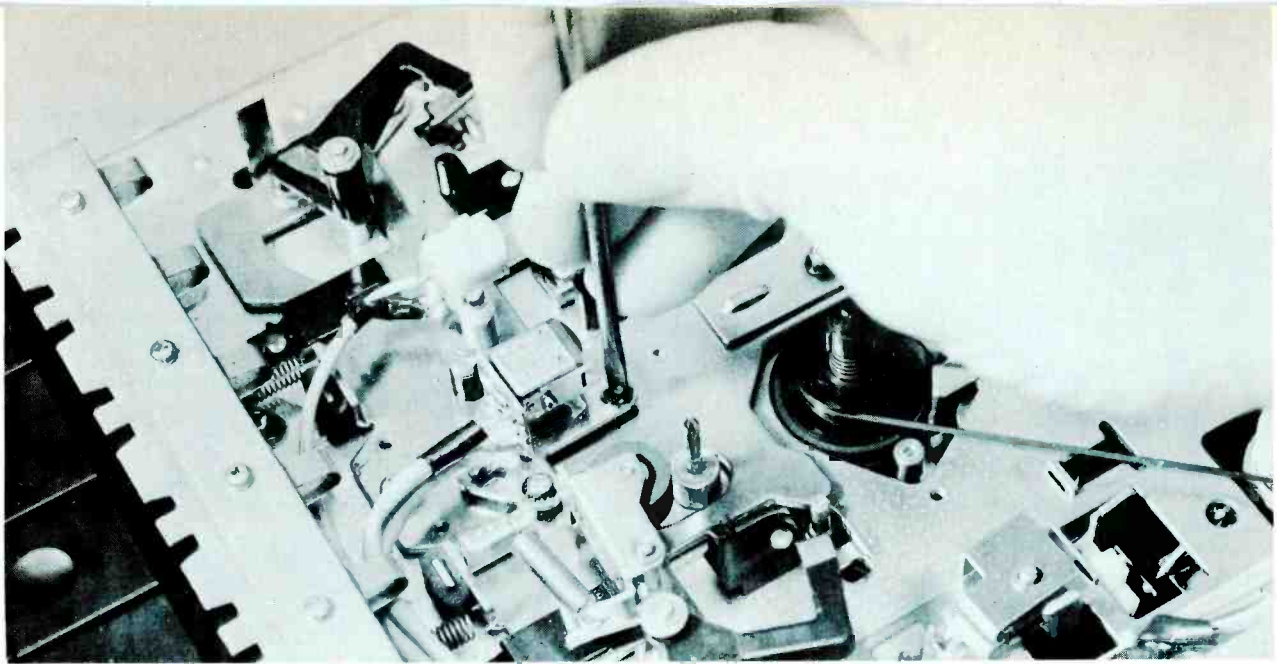

**Step 1.** After you've cleaned and inspected the mechanism, try each of its functions and study movements in the assemblies. First, press the Play button (or move the function selector to Play) and watch which parts move—and how. Test the Fast-Forward and Rewind operations the same way. All assemblies should move freely, without a trace of binding.

**Step 2.** When you depress the Play button, a latch-plate snags the button lever, holding it down until you punch the Stop button. On most machines, pressing Fast-Forward or Rewind also unlatches the Play lever. Usually, the Rewind button latches down too. But don't be alarmed if the Fast-Forward button doesn't; that's common in many mechanisms.

# Workshop on cassette recorders Part 2

By Dewey C. Couch, Forest H. Belt Associates

*The key to efficient service of any mechanical equipment lies in the approach. Last month, the first session of this Cassette Workshop went over the two initial phases of servicing cassette mechanisms. You start with a thorough cleaning, then follow through with visual inspection. Both steps lead toward final analysis.*

*Testing and adjustment, the third and fourth steps of a typical five-point procedure, are covered in this Workshop session. The photos and explana-*

*tions show you how to test the machine's operations, and reveal how adjustments tell you if an assembly is working abnormally.*

*Naturally, this Workshop can't cover every cassette machine. But the operations and assemblies illustrated are typical of many models. The techniques of servicing adapt easily to any cassette mechanism. Follow these steps conscientiously. They'll save you many callbacks.*

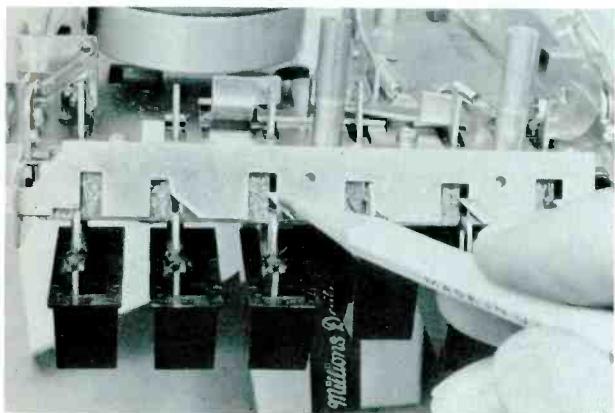
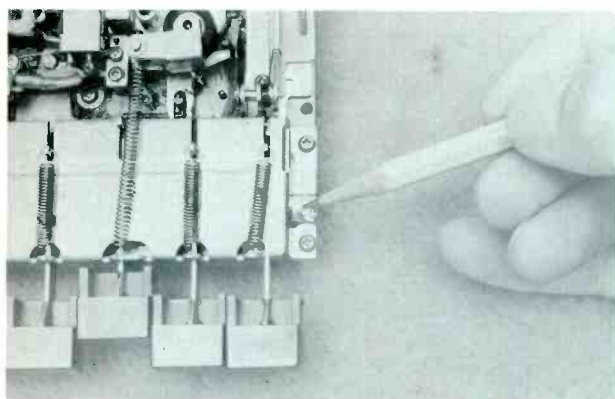

**Step 3.** A spring holds tension on the latch-plate. If a button fails to latch down, first make sure the latch-plate isn't binding. Then check the spring tension. Replace the spring if it's weak. Or, you might find the tabs on the latch-plate worn. The edges should be flat and come to a point. If they're rounded off, replace the plate.

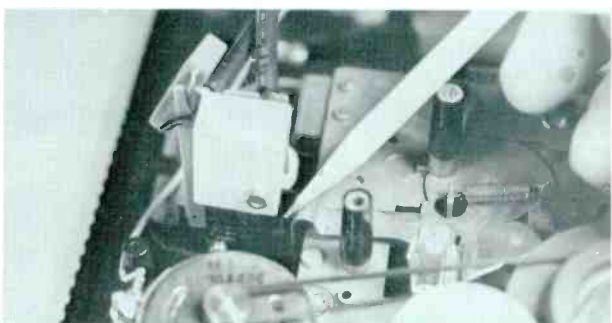
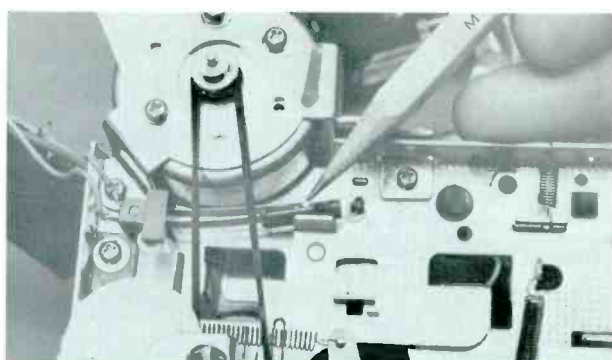

**Step 4.** In most units, the motor doesn't run until you press down a pushbutton. On this machine, a tab on a push-plate moved by the Play, Fast-Forward, or Rewind button closes a leaf switch to start the motor. If the motor fails to start sometimes, that switch is the first thing to check. It might not be closing, or it's intermittent. Some microswitches are adjustable; that is, they can be repositioned. You loosen the mounting screws and position the switch so it just opens when the buttons are unlatched. Then tighten the mounting screws. Recheck to be sure the switch closes when you press Play, Fast-Forward, or Rewind.

**Step 5.** When you press the Play button, the play slide (sometimes same as the head plate) moves forward and completes several mechanical motions. The slide should move evenly and smoothly. If the head plate either binds or feels sloppy, check its retainers and guides. Loose or worn ones have to be tightened or replaced. The plate illustrated here moves on small tracks on the baseplate. Some slides and plates have ball bearings between the play slide and the baseplate. Make sure these bearings have not fallen out. Remember, you might not be the first one to work on the machine.

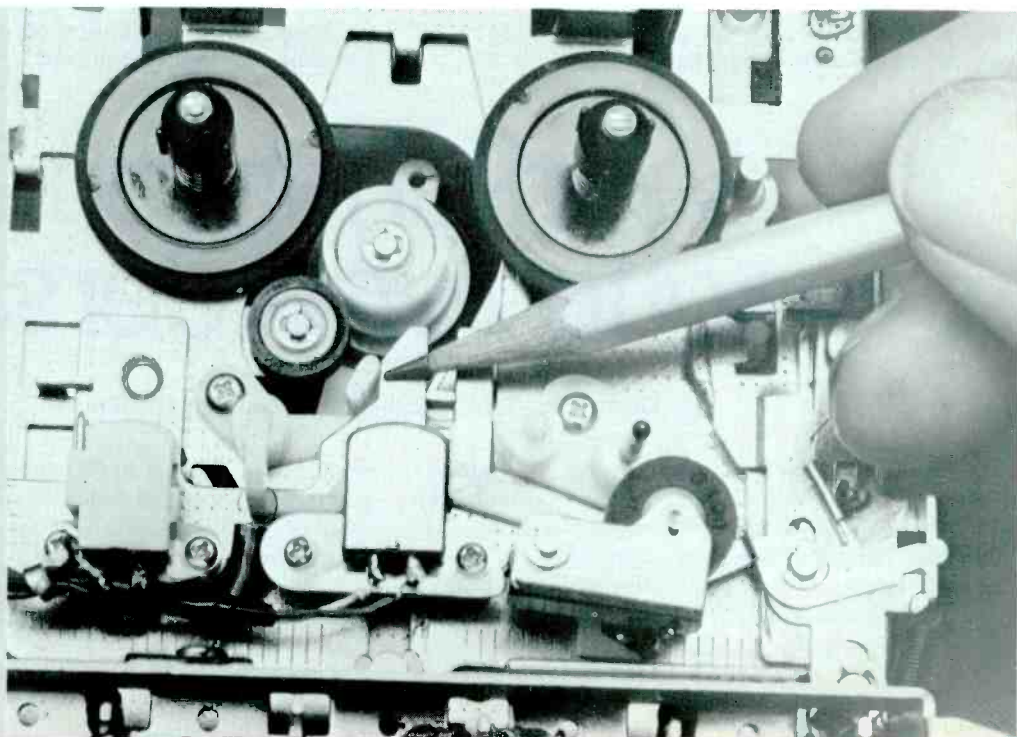

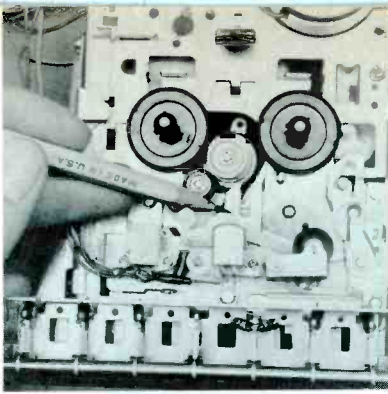

**Step 6.** On most cassette machines, the play slide positions the takeup drive (or rather releases spring tension so the takeup drive can position itself). A cam surface on the slide allows the takeup assembly to pivot, pressing a small idler against the forward-spindle tire. A spring holds tension on the takeup assembly. If takeup torque is insufficient, the tape may spill out of the cassette cartridge. In some mechanisms, a series of holes in the baseplate lets you move the spring end to adjust takeup torque.



**Step 7.** A torque meter, such as this one by Panasonic, can be inserted like a cassette cartridge. It lets you read torque (in grams-per-centimeter) directly on a small slide scale. To adjust torque, you insert the torque gauge, punch the Play button, and move the takeup tension spring from hole to hole until the scale shows about 60 g/cm.

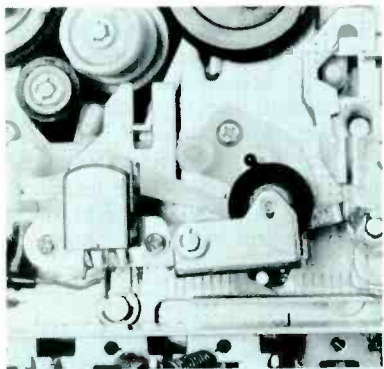

**Step 8.** The pinch-roller assembly mounts on the play slide (head plate). Hence, it too moves forward when you punch the Play button. A heavy spring holds the roller against the capstan with about 10 ounces of pressure. To verify adequate pinch-roller pressure, thread a strip of newspaper between capstan and roller. With no batteries or power connected to the machine, press the Play button. If pressure is sufficient, you can't pull the paper out. However, this test won't spot too much pressure.

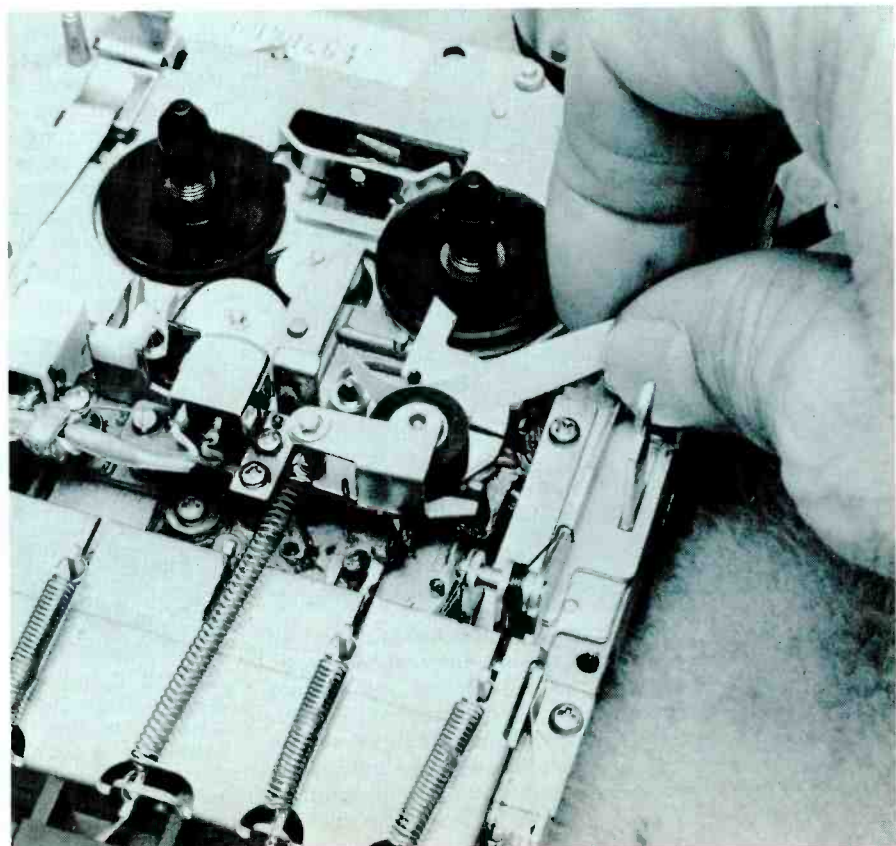

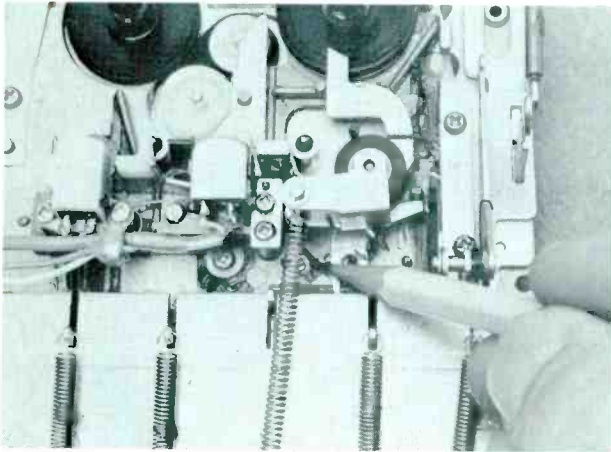
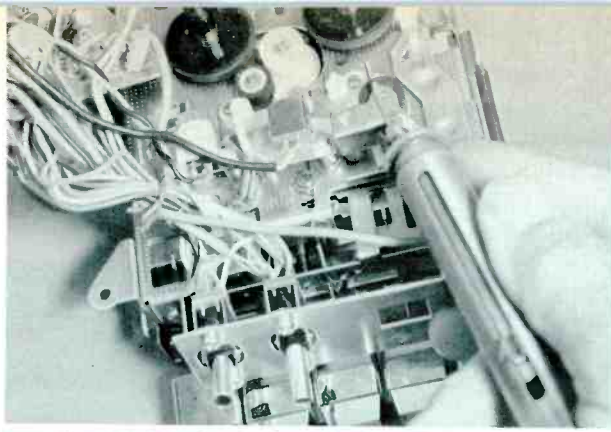

**Step 9.** A more precise method of testing pinch-roller pressure requires a small tension-scale. Punch down the Play button. Hook the scale over the arm near the roller shaft and pull away from the capstan. The scale tells how many ounces of tug pulls the roller away from the capstan. That's the roller pressure. A series of holes in the play slide usually lets you adjust pinch-roller pressure. Move the spring from hole to hole until only 10 or 12 oz. of pull moves the roller away from the capstan.

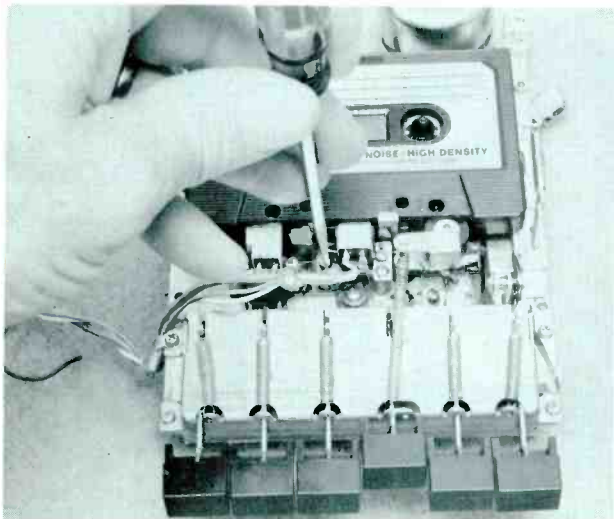

**Step 10.** The record/playback and erase heads mount on the head plate. They move in against the tape when you press the Play button. If for any reason you replace either head, you have to be sure it's properly aligned. Start with the record/play head, regardless of which one you replaced. There are several cassette test tapes around, but you can get by with any good prerecorded tape. Simply play the tape and adjust the head azimuth (tilt) for maximum high frequencies.

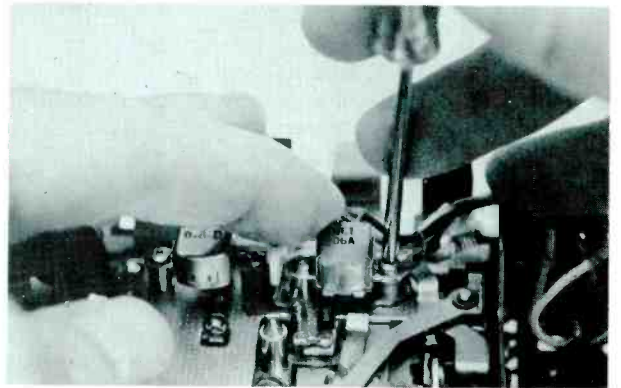
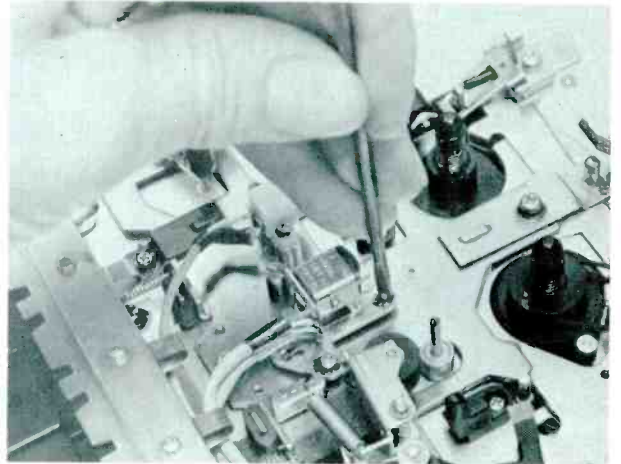

**Step 11.** Head height adjustments are seldom included on cassette machines. Height misalignment of the record/play head usually shows up on stereo machines as crosstalk. That is, sound from one channel (or track) of the tape comes out on the opposite speaker. To correct this fault, you need a special test tape. Adjust head height (you might have to add or remove shims) until both channels are clear, with minimum crosstalk. Use a fresh blank tape to test the erase. Record a minute or so, then erase it (record again with no mike). Then play the same portion to see if all is erased. Shim the erase head to match record/play head height, if necessary.

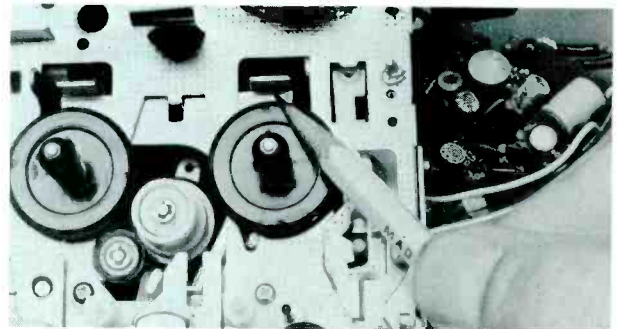

**Step 12.** Spindle brakes seldom are easily adjustable. A linkage from the pushbuttons moves the brake plate away from the takeup and supply spindles during operation. A spring pulls them in for Stop. Make certain the brakes don't drag. The takeup (forward) spindle must turn freely. However, you might find a slight drag on some supply spindles; it holds tape tension to avoid spills.

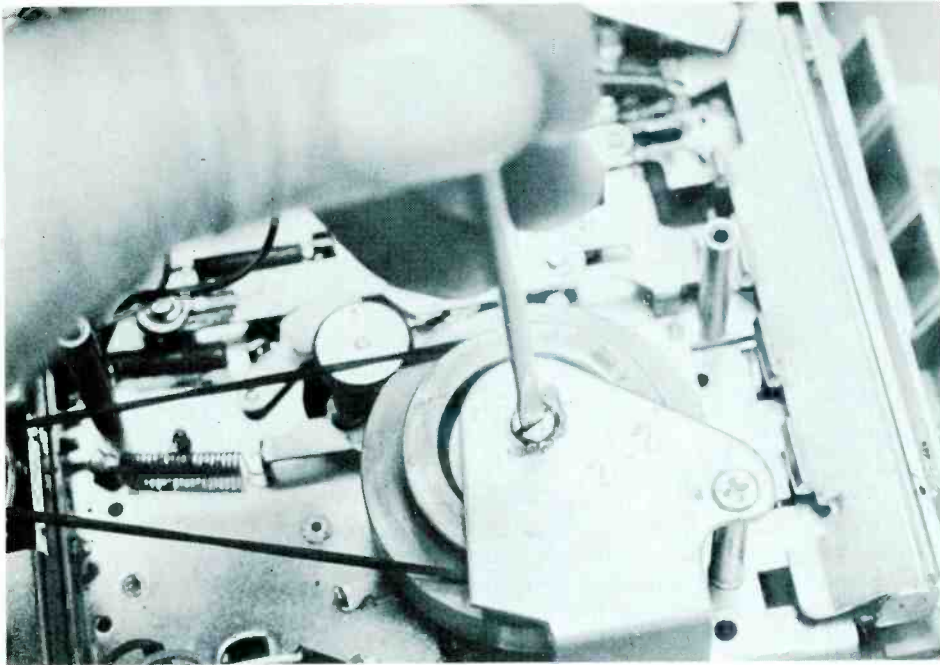

**Step 13.** Some machines have an adjustment to eliminate flywheel play. You simply adjust the screw (or bracket, on some models) for minimum vertical movement. Don't get it so tight the flywheel can't "coast" well when you spin it (keep fingers off the drive surface).

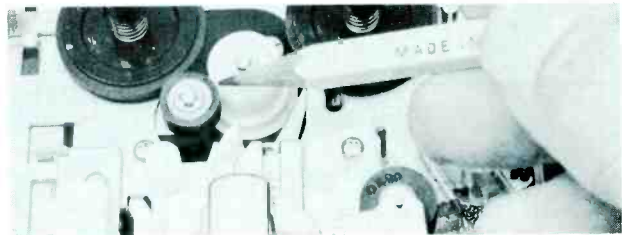
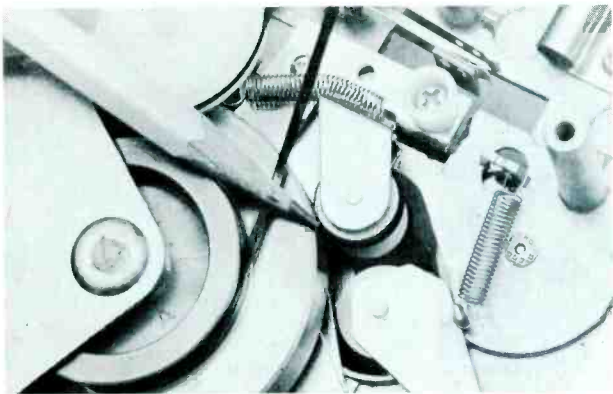

**Step 15.** Rewind and Fast Forward usually are driven from the same flywheel idler. The entire fast-forward drive train, plus an extra idler, comes into use when you press the Rewind button. The rewind idler, the added one, presses against both fast-forward idler and supply spindle, spinning the spindle rapidly in reverse. Usually, you'll find no torque adjustment here. If rewind becomes erratic or too slow, you hunt for weak or unhooked springs or binding idlers.

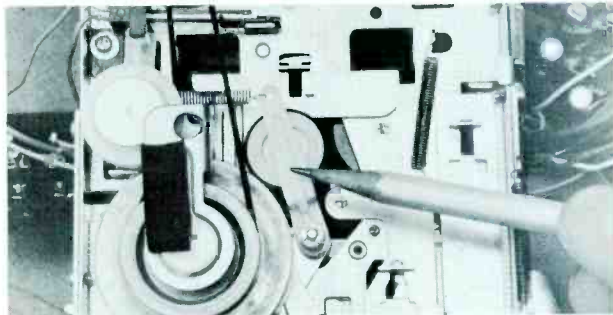

**Step 14.** When you press the Fast-Forward button, at least three mechanical actions must occur: (1) the power switch closes, (2) the spindle brakes release, and (3) the fast-forward drive train engages. Underneath, a rubber-rim idler presses against the flywheel to initiate fast-drive motion. A pulley on the idler shaft drives a rubber belt that turns the fast-forward idler. The idler presses against the takeup spindle, driving it directly. If either of the idlers get sloppy or bind, or if tension springs get weak, tape takeup might become slow or erratic. Few cassette machines have an adjustment for fast-forward torque. Cleaning, and replacement of faulty parts, are your chief remedies.

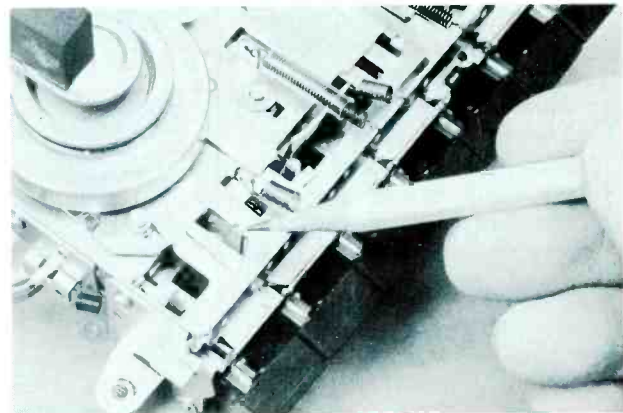

**Step 16.** Normally, the Stop button has only one job. It slides the latch-plate to release whichever button is depressed. Springs do the job of returning assemblies to their resting or nonoperating positions.

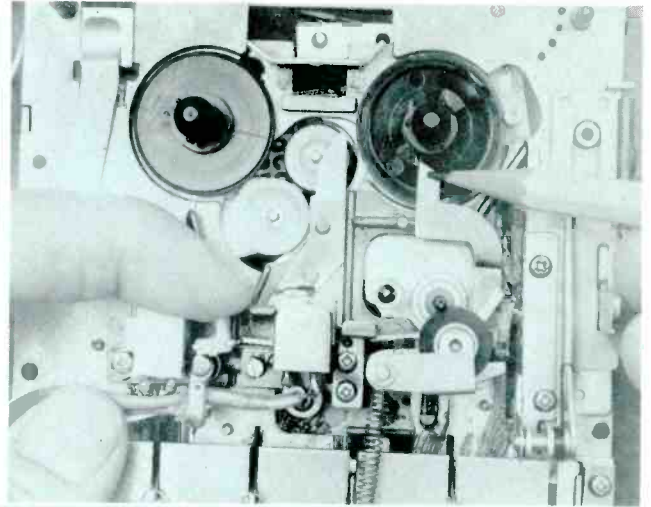
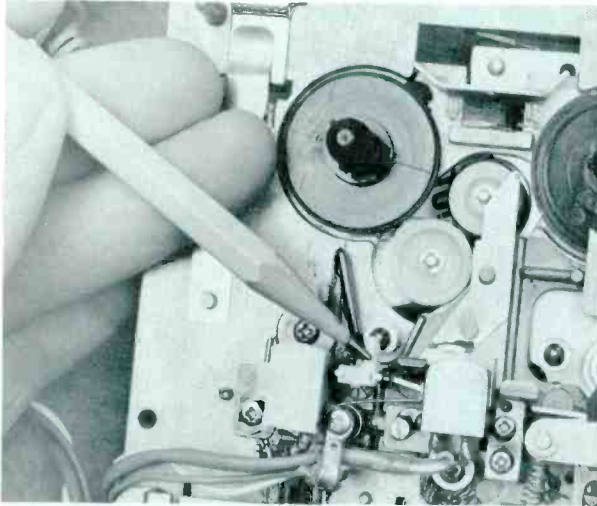

**Step 17.** Most cassette machines stop automatically after a cassette being played or recorded reaches the end of its tape. When the tape has unwound fully from the supply spindle, the spindle stops rotating. The takeup spindle still tries to turn, so the tape pulls taut between the two spindles. The increased tape tension causes an automatic-shutoff feeler to pivot, moving a lever toward the takeup spindle. A protrusion on the spindle pushes on the lever. The other end of the lever engages and slides the latch-plate, releasing the depressed button. Springs return the mechanism to rest.

### NEXT MONTH

By now, you should have a fairly-complete idea of how to go at servicing a cassette machine. From the first Workshop session, you know how to clean and inspect a mechanism. In this session, you have been introduced to most major assemblies. You have seen what to adjust in those that cause trouble. The final two Cassette Workshop sessions cover three basic cassette mechanisms. That should round out your mechanical knowledge of cassettes and prepare you for just about any fault you're likely to encounter in a cassette recorder/player. □

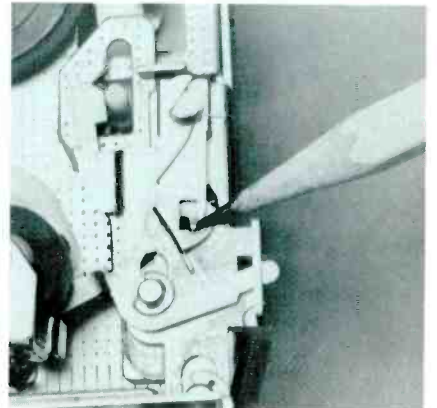
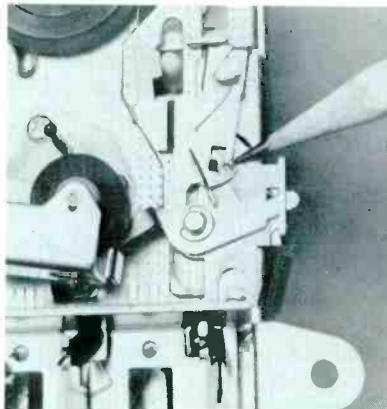
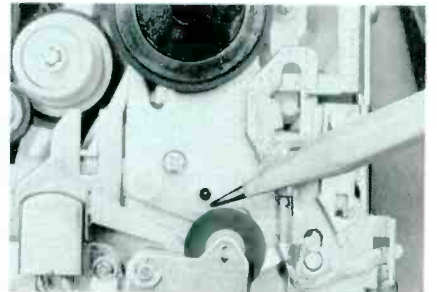
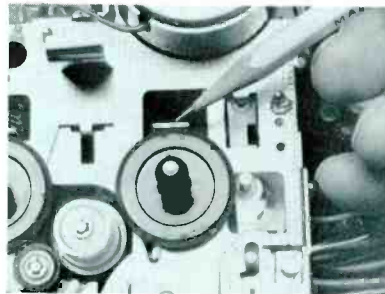

**Step 18.** Pause normally works with both playback and record mode. When you push the Pause button, linkages complete two mechanical actions: (1) the brake plate presses against both spindles, and (2) the pinch roller pulls away from the capstan. Sometimes, the takeup drive idler also moves away from the forward spindle. When you press the Pause button, a small plate pivots and allows a pin on the pause lever to enter a small slot. Release the button, and the pin rides farther into the slot, latching the Pause lever. Press the button again, and the latch-plate pivots on around, releasing the pause lever. Release the button, and springs return the mechanism to its Play or Record mode.

# test equipment report

These features supplied by the manufacturers are listed at no-charge to them as a service to our readers.

If you want factory bulletins, circle the corresponding number on the Reply Card and mail it to us.

## Sensitive Solid-State Multimeter

High sensitivity and high input impedance are two important features of the AVO Electronic Multimeter Model EM-272, an English product distributed here by the **James G. Biddle Company**.

Input impedance is 316,000 ohms-per-volt on both AC and DC voltage ranges, and the 10 voltage ranges are from .03 to 1,000 volts full scale. Accuracy is  $\pm 2.5\%$  for both AC and DC voltage functions, except for the .03 range which is rated at  $\pm 5\%$ . In addition, there are ten decibel ranges.



TV-V sweep selector positions (for viewing two horizontal lines or two vertical fields at the flip of a switch.) Other features include: DC amplifier for measurement of AC and DC signal components; front-panel vector capability; external or internal triggering; a handle that doubles as a tilt stand. The unit sells for \$399.00.

For More Details Circle (51) on Reply Card

## 50 MHz Universal Counter

Model 6250A from **Systron-Donner** performs frequency, multiple-period, time-interval, ratio, and totalizing measurements. The counter features both preset-and manual-trigger level selection, leading-zero suppression, 25 mV RMS input sensitivity, an 8-digit display, BCD output of all measure-



ments, and an autoranging function that selects maximum-display resolution. Each input channel has selectable attenuator and slope controls. A variety of options include a rechargeable battery pack, DC operation, rear signal inputs, a BCD conversion cable, and rack mount kit. The price of the model is \$740.00.

For More Details Circle (52) on Reply Card

## Integrated-Circuit Multimeter

Voltage range protection up to 2KV, automatic polarity with indica-

tion, and linear scales for all ranges are features of the PM2503 from **Philips Test & Measuring Instruments**.

A minimum 10M-ohm input impedance is reported to provide virtually no-load measurements at 3% worst-case accuracy. Pushbutton AC/DC selection, single rotary range selection, plus volts and ohms on the same input sockets are additional features of the meter.

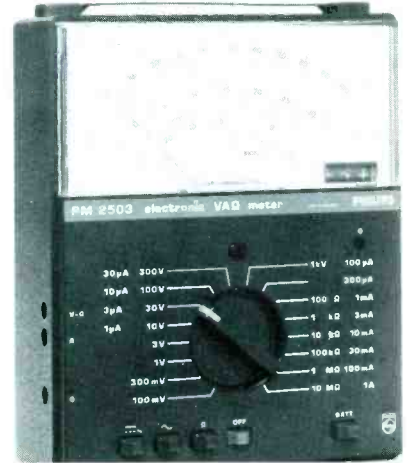

The PM2503 has AC/DC current ranges of  $1\ \mu\text{A}$  to 1A, voltage ranges of 100mV to 1kV, and resistance ranges of 100 ohm to 10M-ohms. No zeroing of infinity adjustments are required on the meter, which uses standard 9-volt batteries. The meter comes with measuring leads and spare fuses and is priced at \$169.00.

For More Details Circle (53) on Reply Card

## 15-MHz Dual-Trace Scope

**Heath** now offers a triggered, dual-trace, DC-to-15-MHz lab-grade oscilloscope. The Heathkit IO-4510 is available in kit form or factory wired.

Features include: 12 ranges of vertical sensitivity, starting at 1 mV/CM; time-base sweep to 100 nS/CM, with typical triggering up to 45 MHz; post-deflection CRT for improved brightness; and vertical delay lines to prevent loss of the first 20 nanoseconds of waveform.

Digitally-controlled logic circuits in the time base provides automatic triggering, so no stability control is necessary. The trigger-select switch and level control allow triggering at any point along the positive or negative slope of the triggering signal.

Price is \$549 for the kit, or \$750 fully wired.

For More Details Circle (54) on Reply Card

## Triggered-Sweep Oscilloscope

**Dynascan's** Model 1431 with a 3-inch CRT is approximately 1/3 the size of comparable scopes, and has a vertical amplifier bandwidth from DC to 10 MHz with a sensitivity of 10 mV/division. In addition to triggered sweep, sync is fully automatic. There are 1, 2, and 5 steps on the calibrated vertical attenuator, and TV-H and

**Ideas for articles?  
Send them to ES, now!**

# Reports from the test lab

By Carl Babcoke

These monthly reports about electronic test equipment are based on actual examination and operation in the *ELECTRONIC SERVICING* laboratory. Observations about the performance, and details of new and useful features are spotlighted, along with tips about how to use the instruments for best results.

A rugged portable tester for both tubes and solid-state components—that's a short description of the new "Hybrider" Model TC28 from Sencore (Figure 1).

Tubes are tested for emission, grid leakage, and shorts. Transistor



Fig. 1 The Sencore Model TC28 tests both tubes and transistors, with all test readings shown on the meter. In addition, an audio tone (Cricket) sounds when a transistor has gain. It's not necessary to connect the transistor leads in any certain way. A tube-testing booklet and simplified instructions for both tube and transistor testing are printed inside the lid. This instrument is an improved combination of the Sencore Mighty Mite VII tube tester and the Cricket transistor tester.

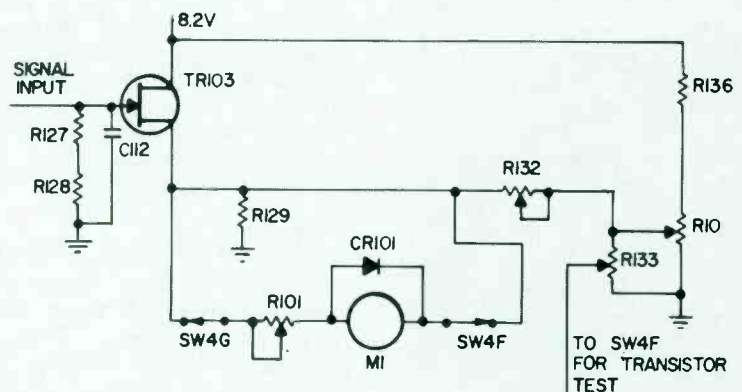

Fig. 2 An FET is used to obtain a very-high input impedance, and the drain-to-source resistance is used as one leg of a bridge which drives the meter for all tube-testing functions. (Courtesy of Sencore)



Fig. 3 Ten pin-elimination switches open the circuit to any duplicate pins to prevent false short indications. The "B" switch sets the heater voltage, "C" switch determines the applied voltage and the load resistance, "D" switch is set for the grid (or rotated to all positions for shorts test), and the "Tubes/Transistors" switch selects the specific tube or transistor test.

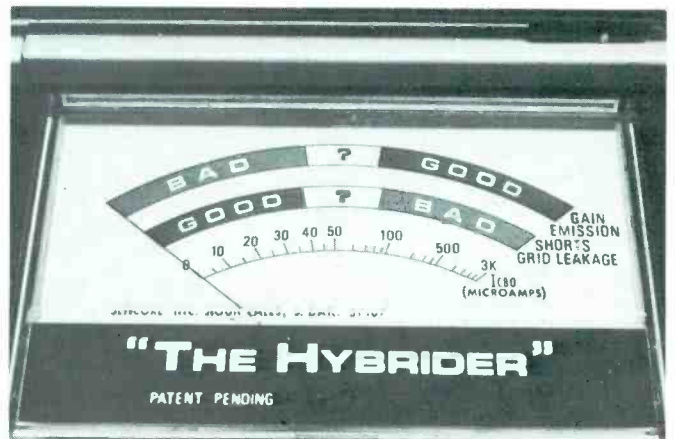

Fig. 4 Three scales are on the meter face. Top one is the good-bad scale for tube emission or transistor gain, center scale is for tube shorts and grid leakage, and the one at the bottom shows transistor leakage in microamperes.



tests (without chart or specifications) include in-circuit and out-of-circuit gain (with both Cricket tone and meter reading), identification of leads, and out-of-circuit leakage. Behind those bare specifications are hidden many unique circuits and features.

All test results (yes, even tube shorts) are read-out on a large 3-3/4 X 6 inch meter. All tube tests have the meter in a bridge circuit, so it will be described first.

### Meter Bridge Circuit

Voltage and current from a tube test don't ever directly reach the meter, because the meter is in a bridge circuit, and isolated by an amplifier (Figure 2).

An FET with 30 megohms of gate resistance (R127 and R128) is wired as a source follower to act as one leg of a bridge. R129, R136, and R10 are the other three legs.

Any positive voltage applied to the gate increases the FET current, unbalancing the bridge and causing the meter to read upscale. Harmful off-scale readings are not possible because of current-limiting resistances plus a diode across the meter.

### Testing Tubes

#### Sockets

The first requirement for testing tubes is a socket of the right physical size, and one which is correctly wired, for each tube to be tested. The TC28 has 13 sockets (plus one transistor socket). Several sockets are almost duplicates, but with the heater wiring changed to minimize set-up problems.

#### Pin elimination

Many modern tubes have an element with more than one pin connection. Without some means of disconnecting one of the pins, a short would be indicated. Therefore, the "A" line of 10 slide switches (Figure 3) open the corresponding pin number. For example, a certain tube might have continuity from pin 1 to pin 7, and also have pin 2 and pin 6 connected

together. "A" switches #6 and #7 should be slid toward the front of the tester to open those pins. A pin-elimination button marked "Reset" moves up all switches simultaneously, when they are not needed.

#### Heater voltage

Setting of the "B" switch de-

termines the heater voltage, with 12 steps supplying 1.35 to more than 50 volts. The Sencore instruction booklet says that only a certain range of voltages, rather than one precise heater voltage, is necessary because the unique design of the heater transformer then will provide the correct voltage when the tube loads the transformer.

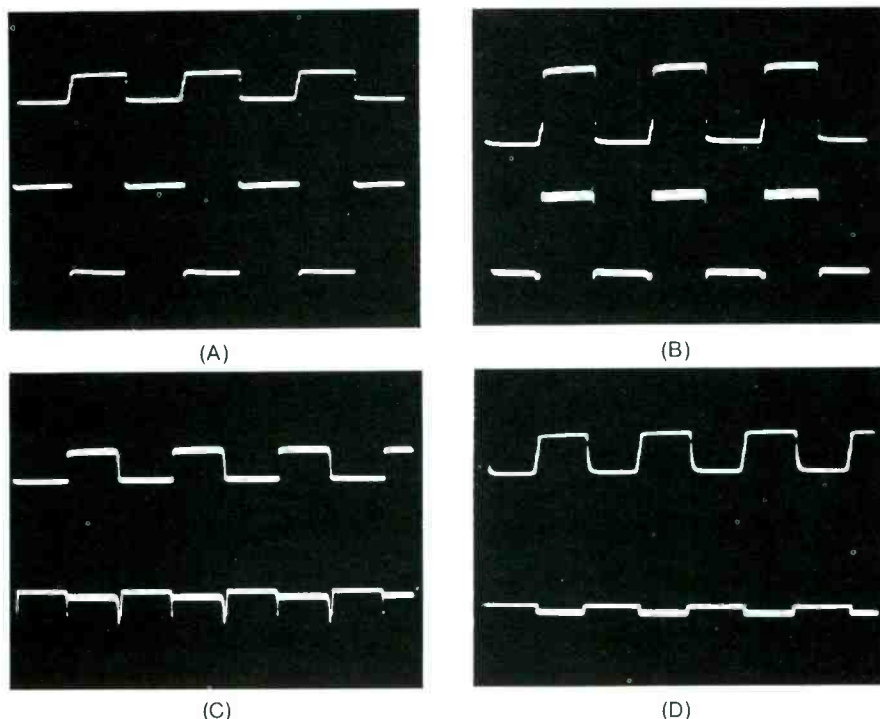

Fig. 5 These are the waveforms and voltages obtained by operation of the six lead-switching pushbuttons. (A) A small NPN silicon transistor was connected yellow to base, green to emitter, and red to collector; then the PNP Gain test was selected and button #1 was pushed. This was the correct (or standard) wiring which produced a "good" reading and a Cricket audio tone. The waveform at top is the base signal, a 2 V p-p 2800 Hz square wave; the DC reading was -.41, evidently from self-rectification of the signal, for without a transistor it was -.15V. Bottom waveform is the 180° 6V p-p collector signal (+2.65 with transistor, +5V without). (B) Same conditions as (A), except button #4 was pushed. Top waveform is the 6V p-p -3.04 V (-5V without transistor) signal at the base. Waveform at bottom is 4V p-p non-inverted one at the red wire, now connected to the emitter. DC voltage is -2.66 with transistor and -5V without. This is the false connection, which also produced a good gain reading and Cricket tone. (C) Button #3 gave no reading. Top trace is the signal at the yellow wire (now the emitter), while the trace at the bottom consists of negative-going edges of the input square waves (now connected to the base). Button #5 also gave no reading. The waveforms were the same except the one at the red wire (now collector) consisted of positive-going pulses. Buttons #2 and #6 gave no waveforms. (D) These are the same conditions as (A), except a 100K resistor was placed in series with the yellow wire (base). Waveform at the base was normal (top trace), but the square waves at the collector were very weak (trace at the bottom). However, the meter showed a normal reading and a normal Cricket tone was heard. When the button #4 for false connection was pressed, the meter read "?", the Cricket tone was weak, and the scope waveform showed very little amplitude of output signal.



Fig. 6 Three EZ Hook clips securely grasp the transistor leads. To use a clip, slide back the sheath to expose the curved hook, insert the wire, then release the sheath, which by spring pressure holds the wire in the hook.

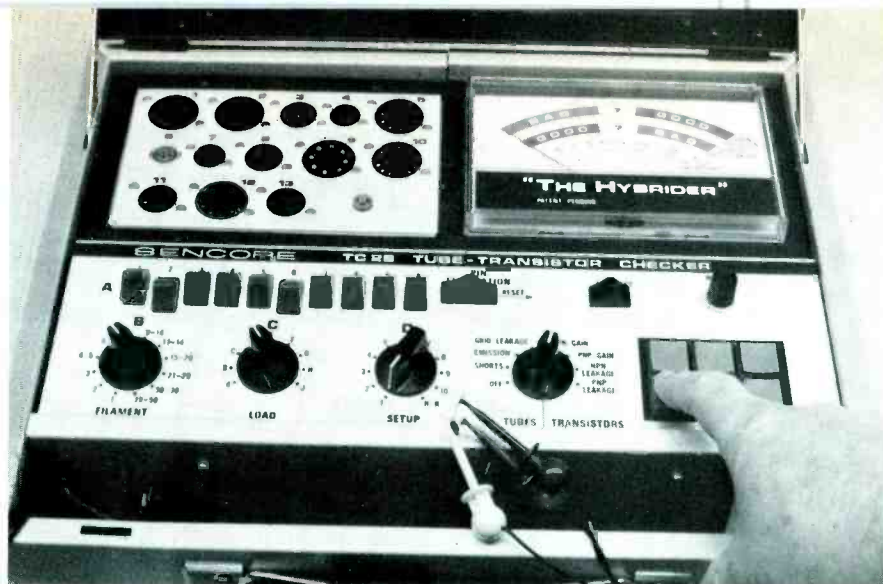

Fig. 7 Six pushbuttons at the lower right corner of the TC28 permit correct connection of transistor and test clips.

### Life test

The switch marked "Life Test" is a part of the heater wiring. When slid to the non-latching position at the right, the tube under test is supplied from the next-lower voltage tap of the transformer.

A tube with normal life expectancy of emission should not show any reduction of emission reading, when operated for a moment or two at the lower heater voltage. Any tube having a noticeable decrease of emission should be regarded with suspicion.

### Voltage and load

Emission is tested by applying an AC voltage to the control grid, and then using the FET/meter circuit to measure the half-wave rectified voltage generated across a cathode resistor of appropriate value.

Accuracy of this test is much better than that of simple emission tests which operate all tubes the same. Switch "C" selects a grid voltage between 22 and 40, and also connects cathode resistors ranging from about 40K for small tubes drawing .5 milliamperes, to 150 ohms for power tubes or rectifiers needing up to 120 milliamperes. Each tube is operated with the voltage and current simulating typical operation.

### Grid and shorts switch

Switch "D" is to be set for the control grid during emission and grid-leakage tests, and then should be rotated through all positions for the shorts test.

Any leakage between elements

acts as the "top" resistance of a voltage divider. About 40 volts RMS is applied to the voltage divider, so lower resistances of leakage produce an increase of the AC voltage, which is rectified by a voltage doubler and applied to the gate of the meter FET.

In simulated-leakage tests, a leakage of 200K (or worse) brought the meter reading up into the red "Bad" area (meter face shown in Figure 4).

If a reading of leakage is obtained on positions 4 and 6 of switch "D", for example, the leakage is between the tube elements that are connected to pins 4 and 6 of the socket in use.

### Grid-leakage test

For the grid-leakage test, the grid is connected to the gate circuit of the meter FET. Then +8 volts DC is applied to all other elements of the tube. Any leakage causes the FET to conduct, and the meter to read.

**This is a very sensitive test.** Leakages of 100 megohms or worse produce readings in the "bad" area of the meter for shorts and grid-leakage. And leakages of 200 megohms or better make the meter read in the "good" area.

### Meter zero

The control marked "Meter Zero" sets the balance of the meter bridge circuit so the meter reads zero when no tube is connected.

With our test sample, zero was obtained at the same point of the control for all three tube-test

functions, and the drift was very small.

### Testing Solid-State Devices

The Sencore instruction manual describes tests for diodes and FET's, but I am confining my remarks to bi-polar transistors.

### Testing transistor gain

When a transistor is operated in the common-emitter circuit, the collector signal is inverted (180°) from the base signal. That fact is the basis for determining transistor gain.

A square-wave signal of about 2 KHz (2.8 KHz in our sample) is generated internally, and it is fed to the base of the transistor under test. At the same time, a DC voltage of the polarity required for PNP or NPN is applied to the collector, and the emitter is connected to tester common.

A non-defective transistor will have an out-of-phase square wave at the collector. Logic circuitry compares the phase of input and output signals, and provides a Cricket audio tone and meter reading when the signals are out of phase. Typical voltages and waveforms are shown in Figure 5.

### No charts or basing diagrams

One small transistor socket is included with the tube sockets, and three EZ Hooks (Figure 6) with long leads are for testing in-circuit, or for checking out-of-circuit transistors which don't fit the socket.

However, it's not necessary for the transistor to be inserted in any

certain way, nor for the clips to be attached to specific leads.

Three clips can be attached to three leads in six different configurations. That's the purpose of the six pushbuttons (see Figure 7). One of the buttons **must** give the correct connections. These same buttons are used for both gain and leakage tests.

Use this sequence for testing transistors in-circuit:

- Turn off power to the receiver, and turn on the tester (there's no voltage to the test clips until a button is pushed), and connect the 3 clips to the transistor leads;
- Rotate the **Tubes/Transistors** switch to the **NPN Gain** position;
- Push the six buttons, one at a time in any sequence;
- A good NPN type should produce a meter reading and cause an audible tone when **two** buttons are pushed. If not, the transistor is bad, it is a PNP polarity, or the circuit loading is too heavy;
- Turn the **Tubes/Transistors** switch to **PNP Gain** and push the six buttons again. A good PNP transistor should give a meter reading and tone when **two** buttons are pushed. If not, the transistor is defective, or the circuit loading is too severe.

Correct polarity is proved by which **gain** test gives a reading and Cricket tone.

Low-value shunting resistances

and capacitances (for example the wiring of most horizontal-output transistors) can simulate a defective transistor. In such cases, the transistor should be removed from the chassis and checked out-of-circuit. Go through the sequence given previously, and if the test is good, add leakage tests in this order:

- Rotate the **Tubes/Transistors** switch to either **NPN Leakage** or **PNP Leakage**, according to the polarity established by the previous tests;
- Push the same two buttons that gave the gain indication. One will show on the meter the B/E leakage in microamperes, and the other shows B/C leakage. Use the chart in the lid of the tester for the limits of permissible leakage according to the type of transistor.

This is as far as the quick tests go. However, collector/emitter leakage and the identification of the elements has not been done yet.

Collector-to-emitter leakage can be very serious in many circuits. Sencore describes a method of testing the leakage, but does not recommend its use as strongly as I do. Two buttons are used to test for gain, and to measure B/E and B/C leakage. Two additional buttons should read full scale without the Cricket tone. These two are measuring the leakage of B/E and B/C in forward directions, and the correct reading is a near short.

That leaves two buttons for measuring both polarities of C/E leakage. In a simulated test, a leakage of 100K caused about 40 microamperes of leakage current, and a leakage of 10K produced about 200 microamperes. These tests have no Cricket audio tone.

Perhaps you wonder why excessive C/E leakage can't be found during the gain tests. Apparently, these tests were made deliberately insensitive to such leakages so in-circuit tests could be done. Leakage in excess of 20 ohms is necessary to interfere with the gain readings.

**I strongly recommend that you learn and use the method of checking C/E leakage, to avoid mistakenly passing a defective transistor.**

#### How to find correct basing

During gain tests, most transistors show normal readings when two buttons are operated. Obviously, the wiring from only one button can match the transistor correctly. With the Hybrider, a transistor needs a gain of only about 3 to 5 to show a good reading during the gain tests. Even with the collector and emitter wiring interchanged, plus some in-circuit loading, many transistors have that much gain. Undoubtedly, that's the reason both buttons seem to work the same. **The method of finding the only correct configuration is to reduce the transistor gain until one button alone gives a reading.**

Sencore arbitrarily has assigned numbers to the six pushbuttons (Figure 8) and standardized the color code as yellow for base, green for emitter, and red for collector. You don't have to use this coding, but it's necessary for use with Figure 8.

Suppose an NPN-type transistor was connected at random to the color-coded clips, and you obtained a reading and Cricket tone on two buttons. Look at the basing chart of Figure 8, and notice which of the elements **does not switch color** for those two buttons. **That one is the base.** Now, another test must be made to determine which is collector and which is emitter.

Connect a 250K pot between base and its clip, then gradually increase the resistance until only **one** button produces a full meter *(continued on next page)*

TEST SWITCHES						
	1	2	3			
	4	5	6			
	TEST SWITCHES					
	$I_{CBO}$	$I_{ECO}$	$I_{BEO}$ (full scale)	$I_{EBO}$	$I_{CEO}$	$I_{BCO}$ (full scale)
LEAD COLOR	1	2	3	4	5	6
GREEN	E	S	B	G	C	D
YELLOW	B	G	C	D	E	S
RED	C	D	E	S	B	G
<b>TRANSISTOR OR FET BASING COMBINATIONS</b>						

Fig. 8 For convenience in analyzing leakages and identifying the leads, Sencore has selected these numbers for the switches, and colors as listed for the test clips. *(Courtesy of Sencore)*

# T & T VALUE SALE

RAY., I. C. C., RCA, SYL.  
FAMOUS MAKE, NEW JOBBER (BOXED) TUBES

• A 6GH8 SPECIAL—100 for \$59 •

## 80% OFF LIST

<input type="checkbox"/> 1B3	5 for \$4.45	<input type="checkbox"/> 6HA5	5 for \$4.30
<input type="checkbox"/> 1V2	5 for \$2.70	<input type="checkbox"/> 6HB7	5 for \$4.85
<input type="checkbox"/> 2AV2	5 for \$3.55	<input type="checkbox"/> 6HQ5	5 for \$5.70
<input type="checkbox"/> 3A3	5 for \$4.55	<input type="checkbox"/> 6HV5	5 for \$10.55
<input type="checkbox"/> 3AT2	5 for \$4.40	<input type="checkbox"/> 6JC6	5 for \$5.05
<input type="checkbox"/> 3GK5	5 for \$4.35	<input type="checkbox"/> 6JEB	5 for \$9.95
<input type="checkbox"/> 3HA5	5 for \$4.30	<input type="checkbox"/> 6J56	5 for \$8.30
<input type="checkbox"/> 3HM5	5 for \$4.30	<input type="checkbox"/> 6JUB	5 for \$5.00
<input type="checkbox"/> 4B26	5 for \$4.20	<input type="checkbox"/> 6KA8	5 for \$5.50
<input type="checkbox"/> 5GH8	5 for \$5.30	<input type="checkbox"/> 6KE8	5 for \$6.85
<input type="checkbox"/> 6AX4	5 for \$4.50	<input type="checkbox"/> 6KM6	5 for \$10.05
<input type="checkbox"/> 6AY3	5 for \$4.20	<input type="checkbox"/> 6KN6	5 for \$8.85
<input type="checkbox"/> 6BK4	5 for \$8.35	<input type="checkbox"/> 6KT8	5 for \$6.10
<input type="checkbox"/> 6CG3	5 for \$4.40	<input type="checkbox"/> 6KZ8	5 for \$4.60
<input type="checkbox"/> 6CG8	5 for \$4.85	<input type="checkbox"/> 6LB6	5 for \$9.60
<input type="checkbox"/> 6CJ3	5 for \$4.20	<input type="checkbox"/> 6LQ6	5 for \$9.95
<input type="checkbox"/> 6DQ6	5 for \$6.05	<input type="checkbox"/> 8FQ7	5 for \$3.35
<input type="checkbox"/> 6DW4	5 for \$4.20	<input type="checkbox"/> 12AX7	5 for \$3.15
<input type="checkbox"/> 6EA8	5 for \$4.40	<input type="checkbox"/> 12BY7	5 for \$4.05
<input type="checkbox"/> 6EH7	5 for \$4.30	<input type="checkbox"/> 12G7W	5 for \$6.25
<input type="checkbox"/> 6EJ7	5 for \$4.05	<input type="checkbox"/> 17JZ8	5 for \$4.05
<input type="checkbox"/> 6FQ7	5 for \$3.35	<input type="checkbox"/> 21G5	5 for \$5.65
<input type="checkbox"/> 6GF7	5 for \$5.95	<input type="checkbox"/> 23Z9	5 for \$5.35
<input type="checkbox"/> 6GH8	5 for \$3.55	<input type="checkbox"/> 31LQ6	5 for \$9.05
<input type="checkbox"/> 6GJ7	5 for \$3.40	<input type="checkbox"/> 33G7	5 for \$7.20
<input type="checkbox"/> 6GM6	5 for \$4.35	<input type="checkbox"/> 38H7	5 for \$8.20
<input type="checkbox"/> 6GU7	5 for \$4.70	<input type="checkbox"/> 38HK7	5 for \$8.05
<input type="checkbox"/> 6GY6	5 for \$3.85	<input type="checkbox"/> 42KN6	5 for \$8.15

FREE—\$300 list of IF Cans and Coils  
with any purchase of 100 tubes

## TRANSISTORS XACT. REPLACEMENT (BOXED)

### UP TO 90% OFF LIST

<input type="checkbox"/> SK3004	10 for \$1.90	<input type="checkbox"/> SK3052	5 for \$3.90
<input type="checkbox"/> SK3009	5 for \$3.90	<input type="checkbox"/> SK3054	5 for \$4.50
<input type="checkbox"/> SK3010	5 for \$2.10	<input type="checkbox"/> SK3082	5 for \$3.90
<input type="checkbox"/> SK3018	5 for \$2.25	<input type="checkbox"/> SK3103	5 for \$3.00
<input type="checkbox"/> SK3021	5 for \$3.15	<input type="checkbox"/> SK3114	5 for \$2.40
<input type="checkbox"/> SK3024	5 for \$3.30	<input type="checkbox"/> SK3124	5 for \$2.10
<input type="checkbox"/> SK3025	5 for \$4.50	<input type="checkbox"/> SK3132	5 for \$2.60
<input type="checkbox"/> SK3040	5 for \$3.75	<input type="checkbox"/> ECG 155	5 for \$4.90
<input type="checkbox"/> SK3041	5 for \$4.20	<input type="checkbox"/> ECG 131	5 for \$3.90
<input type="checkbox"/> SK3042	5 for \$6.60	<input type="checkbox"/> HEP 707	5 for \$15.00

## ANTENNA SUPPLIES

<input type="checkbox"/> Flower Pot Antennas	\$2.95
<input type="checkbox"/> With Impedance Switch	\$3.95
<input type="checkbox"/> 59U F Connectors	100 for \$10.00
	1,000 for \$80.00

## YOKES—TUNERS

<input type="checkbox"/> Tuner inc. 6GS7, 6HA5	\$1.95
<input type="checkbox"/> Combo Tuners inc. tubes	\$4.95
<input type="checkbox"/> Y105—Y94—Y130	ea. \$6.95
<input type="checkbox"/> Zen. Color Yoke 95-2532, repl.	\$11.95
<input type="checkbox"/> RCA Color Yoke 906214-501	\$8.95

## ZENITH MODULES

<input type="checkbox"/> 9-50—9-59—9-79	ea. \$3.95
---	------------

## AUDIO

<input type="checkbox"/> 60 Min. Cassette Irish Tape	6 for \$2.50
<input type="checkbox"/> 84 Min. 8-Track Irish Tape	3 for \$3.00
<input type="checkbox"/> Equiv. Shure—N44, N77, N91	ea. \$2.95
<input type="checkbox"/> Equiv. Pickering V15	2 for \$5.00
<input type="checkbox"/> BSR Cartridges—SX5M, SX1H, SC5M	4 for \$5.00
<input type="checkbox"/> Remote Mikes Min. Plug	4 for \$6.00
<input type="checkbox"/> Stereo Head Set Min. Plug	2 for \$5.00
<input type="checkbox"/> Stereo Head Sets	ea. \$3.95
<input type="checkbox"/> Stereo Dual Mikes Ampex	2 for \$7.50
<input type="checkbox"/> Speaker Kit	\$5.95
<input type="checkbox"/> 2—4", 2—5", 2—4X6, 4—6"	All 10 for \$12.00

## GENERAL

<input type="checkbox"/> Color Conv. Assy.	ea. \$1.95
<input type="checkbox"/> 19 & 25" <input type="checkbox"/> 21" Color Boosters	3 for \$11.95
<input type="checkbox"/> 2.5 Amp. 1000 PIV IR170	20 for \$3.50
	100 for \$11.00
<input type="checkbox"/> 6500 PIV ITT Focus Rect.	10 for \$5.00
<input type="checkbox"/> Zen. Voltage Tripler—212-136	3 for \$12.00
<input type="checkbox"/> 3.58 Crystal Osc.	4 for \$3.00
<input type="checkbox"/> 117V-12V DC H. D. Transformer	ea. \$1.50
	10 for \$12.00
<input type="checkbox"/> Blue Lateral Magnets with P.R.	10 for \$10.00
<input type="checkbox"/> Dual Diode Repl. RCA 135932	ea. \$2.95

Minimum Orders \$35—F. O. B. Brooklyn, N.Y.  
Catalogs \$1—Refundable Upon Your Order

**T & T SALES CO.**

4802 AVENUE K

BROOKLYN, N. Y. 11234

Phone: (212) 241-5940

(continued from previous page)

reading and a clear Cricket tone (the other button should produce weak gain and a weak garbled tone, or none). The button giving the full reading is the one with the correct wiring for that transistor.

Any device which gives normal gain readings on two buttons with 100K or more of resistance in series with the base lead is an FET.

## Summary

There are a few precautions about using the Sencore TC28 "Hybrider" tube and transistor checker. The first one is common to any emission tube checker. A tube with an open plate, screen grid, or plate (or a bent pin which misses the socket) probably will test as good, but not work in the receiver. That's because only the heater, cathode, and grid are used during emission tests.

There are no tests to determine whether a transistor is made of silicon or germanium material; a minor problem in finding suitable replacements. A test for C/E leakage is provided, and you should check every out-of-circuit transistor for such leakage.

In actual use, the Sencore TC28 performed very well in finding bad tubes and transistors. Set-up preparations are minimal, and the test results definite. There was no perceptible drift of meter zero.

Perhaps the best features for checking transistors were the six pushbuttons that make prior knowledge of the basing unnecessary, and the universal method of testing gain and leakage so a specifications chart is not required. The instrument should fulfill very well its function as a universal tube and transistor tester for service calls or sales counter uses. □

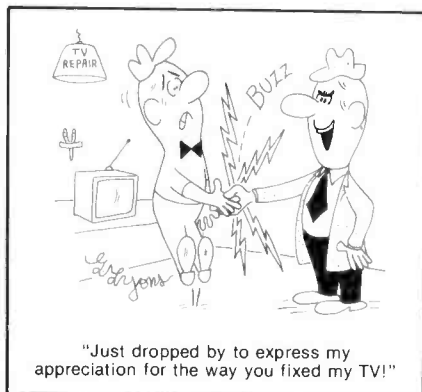

"Just dropped by to express my appreciation for the way you fixed my TV!"

# productreport

These features supplied by the manufacturers are listed at no-charge to them as a service to our readers. If you want factory bulletins, circle the corresponding number on the Reply Card and mail it to us.

## D12 Engraver

The D12 engraver from Mountain West Alarm permanently marks and identifies valuables and equipment.

The D12 engraves steel, plastic, copper, brass, wood, or glass. The replaceable carbide tip is driven by a high-speed reciprocating motor at



7,200 strokes-per-minute. The calibrated stroke-adjustment dial regulates the length of stroke, and the depth of the engraving—from fine lines to deep marks. For continuous duty, a diamond point is available. The compact engraver weighs two pounds, and costs \$15.75 (price includes the carbide tip.)

For More Details Circle (55) on Reply Card

## Chemical Safety Light

A cold light that operates by chemical photo-luminescence has been introduced by Cole-Flex. The "Coleflex Chemlite" emergency light is compact and self-contained. Easily activated by breaking the inner vial containing a chemical catalyst, one light can illuminate an average room. Each device is capable of producing over three hours of working light, which then reduces to a soft glow for as long as 24 hours. The light shines in all directions and is not confined to a narrow beam.

Encased in a foil envelope, each light is six inches long and cost \$1.49, or \$9.95 for a wall-mountable canister containing six units. The light has a shelf life of at least two years when stored at normal temperatures.

For More Details Circle (56) on Reply Card

## Conference Call Attachment

Three-way telephone calls are possible with two models of **Telco** telephone attachments. Model CCA-200 is for office-type multi-line telephones, and the CCA-220 is for private residential-type phones. Each unit re-



quires two separate phone numbers, but supposedly saves time and money by eliminating operator assistance, callbacks, and credit-card calls. The attachment may be used to have calls forwarded to another location, or to receive an office call at home. The units require no batteries or AC power. The CCA-200 sells for \$34.95, and the CCA-220 for \$29.95.

For More Details Circle (57) on Reply Card

## Magnetic Tool Retriever

"Super Mag" from **3B&D Products**, retrieves parts or tools that fall into hard-to-get-to places. The magnetized tool resembles a flashlight with a long flexible tail on the front. The "Super Mag" has two pushbuttons: one turns on the illuminator, a fiber-optic light which helps locate the lost item; the



other button energizes an electromagnet which locks onto the dropped item for easy retrieval. The tool-retriever operates on two standard flashlight batteries.

For More Details Circle (58) on Reply Card

## TV-Tective

TV-Tective is a compact, solid-state-circuitry burglar alarm for any television set or console stereo. The product features simple installation, self-contained power source, and can be adapted to protect other electrical

appliances in the home or office. Once installed, the alarm remains dormant until needed. If a burglar pulls the cord from the wall socket, the alarm emits a loud, oscillating pitch. Even plugging the cord back in won't shut off the alarm—only the owner knows the secret location of the switch. Retail price of the TV-Tective is \$14.88.

For More Details Circle (59) on Reply Card

## Cordless Screwdriver

**Disston, Incorporated** has manufactured the first cordless electric screwdriver to provide flexible, "work-anywhere" cordless convenience without the danger of electrical shocks.

Powered by rechargeable nickel-cadmium batteries supplied by the General Electric Company, the screwdriver provides enough power to drive 80 one-inch screws into pine without pre-drilling. The batteries can be recharged more than 500 times, simply by plugging the screwdriver's charger into a wall outlet for 16 hours. There is no danger of damaging the batteries or screwdriver by overcharging.

Throughout its period of use, the screwdriver delivers full power, rather than growing weaker as the charge wears down.

For More Details Circle (60) on Reply Card

# Buckle up for savings with Perma Power Color-Brite



**BRITENER SALE!**  
~~\$24.60~~ \$19.95  
 SAVE \$4.65  
 AND THE BUCKLE'S FREE!

For a limited time, you can save \$4.65 on a package of four Model C-511 Color-Brites—over a dollar a britener—and get a handsome belt buckle free.

Antique reproduction belt buckles are all the rage today. We've selected four of the most wanted designs—(Wells Fargo, Winchester Rifles, Budweiser and Rolls Royce) in brass and pewter finishes. They normally sell for \$5.95 or more, and fit most belts.

Perma Power Model C-511 Color-Brites are the most needed today. They immediately improve sharpness, detail, and contrast of faded color pictures. They normally sell for \$6.15 each, and fit most sets. Hurry to your distributor today!

**Perma Power**

Chamberlain Manufacturing Corporation  
 Perma Power Division  
 845 Larch Avenue, Elmhurst, Illinois 60126  
 Telephone (312) 279-3600

For More Details Circle (16) on Reply Card

### Add-A-Fuse

A fused power-tap from **3B&D Products** reportedly simplifies the installation of electrical appliances. The device has prongs on one side of an insulating board that snaps into an

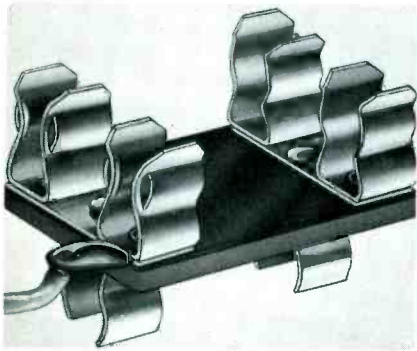

existing fuse clamp. On the opposite side of the board there are two fuse clamps—one receives the fuse for the circuit in which the device is plugged; and the other picks up and fuses the hot side of power to the new installation. A piece of hookup wire is attached for connection to the appliance.

For More Details Circle (61) on Reply Card

### Self-Stick Signs

Weatherproof, self-adhesive signs for company identification are available now in six designs from **Seton Name Plate Corporation**. Stock sizes range from 3 x 4½ inches to 16¼ x 24½ inches, or in round sizes from a diameter of 3½ inches to a diameter of 20 inches. The signs are said to be washable, will resist road grime and weather, and won't wrinkle or buckle. Standard script lettering is available at no extra cost.

For More Details Circle (62) on Reply Card

### Universal Drill Bit

Model II bit, a development of the **Unibit Corporation**, enables the drilling of eight sizes of round holes from 9/16-inch to 1-inch, by means of a single bit.

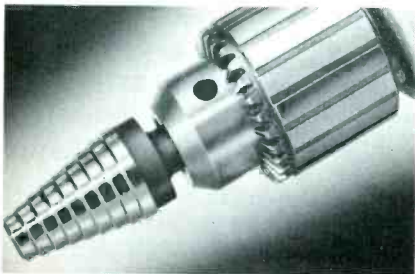

Designed for use with any 1/2-inch drill chuck, Model II works well with both hand-held electric drills and drill-press equipment. It is effective in drilling round holes in thinner gauges of sheet metals such as steel, copper, brass, and aluminum, as well

as plastics and wood.

The bit is made of industrial-grade high-speed steel, heat-treated and tempered to assure maximum strength for long-wearing use.

For More Details Circle (63) on Reply Card

### Japanese Transistors

Seven transistors for replacement use in all major Japanese-built entertainment systems have been added to the existing line available from **International Rectifier Corporation**. The additional devices are: 2SA564A, 2SB187, 2SC281B, 2SC403A, 2SC535B, 2SC682A, and 2SC772. These increase the line to 31 units.

It is reported that Japanese-built television sets accounted for 28 percent of all sets sold in the United States in 1973, which is higher than the percentage of any domestic manufacturer. This fact proves the need for the new transistors.

For More Details Circle (64) on Reply Card

### Flameproof Film Resistors

Safety first is the primary concern of the flameproof film resistors developed by **RCA**. These resistors won't flame or short under the most severe overloads, and may be used in consumer instruments of any make.

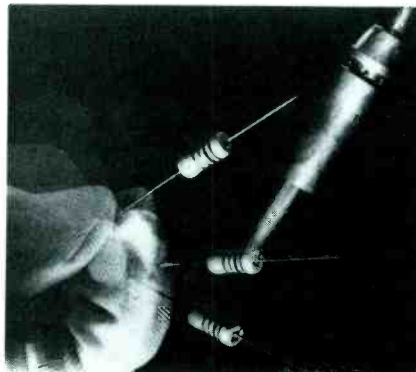

The flameproof film resistors have a 2 percent tolerance and are available in 1/2 watt, 1 watt, and 2 watt ratings. There are 61 standard resistance values, ranging from 10 ohms through 1 megohm, in each wattage rating.

For More Details Circle (65) on Reply Card

### Repair Adhesive

**DuHesive 300**, from **Dubois Chemicals**, is designed for use in the assembly, maintenance and repair of audio and video equipment. The adhesive bonds with strengths up to 4,000 pounds per square inch, and only one drop of DuHesive 300 is needed per square inch of area. No pre-mixing or heating is required. One ounce of the product contains over 1,800 one-drop applications for plastics, rubber, metals, glass, and ceramics. The adhesive is colorless and resistant to chemicals.

For More Details Circle (66) on Reply Card □



## Death of a Salesman.

To find out how you can set up your own Defensive Driving Course, write: The National Safety Council, 425 N. Michigan Ave., Chicago, Illinois 60611.

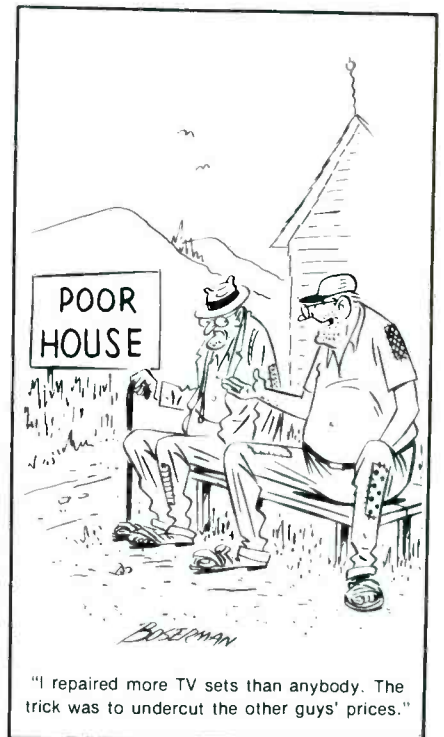

**FREE CATALOG**  
**HARD-TO-FIND PRECISION TOOLS**  
 Lists more than 2000 items—pliers, tweezers, wire strippers, vacuum systems, relay tools, optical equipment, tool kits and cases. Also includes ten pages of useful "Tool Tips" to aid in tool selection.

**JENSEN TOOLS**  
 4117 N. 44th Street, Phoenix, Ariz. 85018

For More Details Circle (26) on Reply Card

**DISTRIBUTOR OF EUROPEAN ELECTRONIC PARTS**

TELEFUNKEN • BLAUPUNKT • GRUNDIG • METZ • NORELCO • KORONETTE • PHONO • SONIC • LION • KUBA • KAISER • IMPERIAL • PE • DUAL • NORMENGE AND MANY OTHERS

**GERMAN ELECTRONICS SERVICE CORP.**  
 63-04 39th Ave. P.O. Box 266  
 Woodside, N.Y. 11377  
 Tele (212) TW9-3900

For More Details Circle (27) on Reply Card  
**ELECTRONIC SERVICING**

# audio systems report

These features supplied by the manufacturers are listed at no-charge to them as a service to our readers. If you want factory bulletins, circle the corresponding number on the Reply Card and mail it to us.

## Altec Loudspeaker-Enclosure Design Manual

Altec Corporation has produced a fully-illustrated 32-page publication for the do-it-yourself audio enthusiast, called "Loudspeaker Enclosures—Their Design and Use."

Priced at \$2.00, the publication was created to provide an easy-to-digest source of data for use in designing and constructing enclosures of predictable and satisfactory performance when used with Altec's loudspeakers.

The publication covers the entire range of enclosures, with topics including the function of the enclosure, loudspeaker design theory, the various types of enclosures—from infinite baffle and bass reflex enclosures—to tuning the bass reflex port.

For More Details Circle (67) on Reply Card

## Open-Air Headphones

The Marquis Open Air Headphone, Number 30-5205, features cushioned earpieces, adjustable padded headband, 8-ohm impedance and a 20-20K Hz frequency response. The GC Electronics product matches all amplifiers with output from 4-through



16-ohms, has a power-handling capacity of 250m/watts and sensitivity of 110 db/0.4v.

For More Details Circle (68) on Reply Card

## Under-Deck Speaker

The KK50-UD, from Acoustic Fiber Sound Systems, is designed to be heard and not seen. The speaker fits under the rear deck of a car's trunk, cinched tightly in place with mounting straps and a poly-buckle that are

furnished. The corrugated enclosure houses a wide-range 5-inch speaker of the acoustic-suspension type having a 10-ounce ceramic magnet. Two corrugated panels set at right angles, and bonded together with moisture-resistant adhesive, reportedly cancel unwanted sound waves. Price of the KK50-UD speaker is \$39.95.

For More Details Circle (69) on Reply Card

## High-Fidelity Tweeters

Three tweeters—a square, a pin-cushion, and a round-dome type—from International Importers, are available

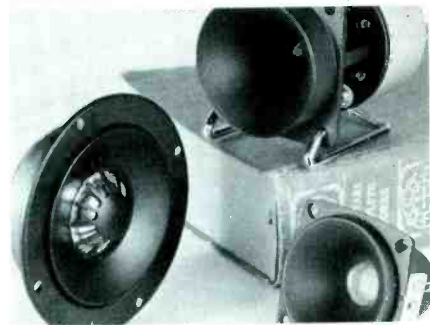

in impedances of 4, 8, 16, 30 or 45 ohms. HT-3 is a square, horn-type tweeter with response between 3,000 and 20,000 Hz. It has a 2.1 ounce magnet, and a maximum power output of 30 watts.

The HT-15 is a pin-cushion style,

## A Classroom in Your Mailbox!

STUDY  
Two-Way Radio  
THROUGH

**MTI**

**MOTOROLA TRAINING  
INSTITUTE**

Home Study Course

Professional Training in a Unique Career Field  
Approved for VA Reimbursement

Providing Training to the Industry Since 1960  
Write for Free Course Outline - No Obligation  
We have no salesmen or representatives

**MTI** SUMMERDALE, PA. 17093

For More Details Circle (17) on Reply Card

December, 1974

## Oneida INSTANT-WELD<sup>®</sup> ALPHA CYANOACRYLATE ADHESIVE

THE MOST ADVANCED FORMULAS FOR  
INDUSTRIAL AND PROFESSIONAL USE

- One component only—no mixing required.
- Versatile—bonds metal, glass, phenolics, rubber, ceramics and plastics.
- Extremely rapid setting—seconds, not hours.
- Economical—one drop covers one square inch and costs less than ¼c.
- Very strong—up to 3000 lbs./in<sup>2</sup> tensile strength
- Fingertip pressure only—no clamps or fixtures
- Sets at room temperature—no heat needed
- Does not use solvents or catalysts.

SAVE UP TO 50% BY BUYING OUR BIG, ECONOMY BOTTLE,  
UP TO 1,900 "ONE DROP" APPLICATIONS. ORDER FROM  
YOUR ONEIDA DISTRIBUTOR OR DIRECT FROM US.



Ship \_\_\_\_\_ bottles @ \$8.95 each. 759-D

Name \_\_\_\_\_

Company \_\_\_\_\_

Address \_\_\_\_\_

City \_\_\_\_\_ State \_\_\_\_\_ Zip \_\_\_\_\_

TERMS: Check with order - we pay postage.

**Oneida** ONEIDA ELECTRONIC MFG. INC.  
Meadville, Pa, 16335

For More Details Circle (18) on Reply Card

horn-type tweeter with 5,000- to 20,000-Hz frequency range, a 1.3 ounce magnet, and a maximum power output of 20 watts.

A round, dome-type tweeter, Model HT-49, has a frequency range between 4,000 and 18,000 Hz, a 4.45-ounce ferrite magnet, and a maximum power rating of 50 watts.

For More Details Circle (70) on Reply Card

### Underwater Loudspeaker

The UW30 from **Altec Corporation** is said to be a breakthrough in the underwater reproduction of voice and music. Before the UW30, underwater speakers were known for short life span and poor sound quality. The model reproduces music for synchronized swimming and ballet, and reproduces speech for teaching and announcements. Installation may be permanent or portable. Speaker life is extended because each unit is housed in solid epoxy, and is resistant to chemicals and moisture.

For More Details Circle (71) on Reply Card

### Monaural Amplifier

**Crown International** introduces the Crown M-600, a high-power, single-channel amplifier designed to provide continuous operation at rated power, at any rated frequency. Protected from shorts, open circuits, mismatch,

RF burnout, and thermal overload, the M-600 amplifies signals from DC to 20 KHz and provides 70 volt unbalanced line output at 600 watts of

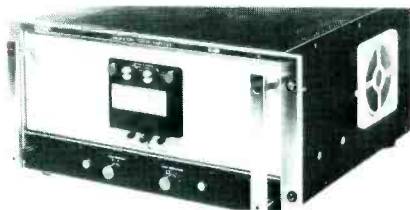

continuous power into 8 ohms (1000 watts into 4 ohms) indefinitely. Cooling is self-contained, and the changeable plug-in board enables the unit to drive any type load without overheating.

For More Details Circle (72) on Reply Card

### Noise-Cancelling Microphone

A noise-cancelling microphone from **Astatic** is sensitive to spherically-shaped sound waves and not to flat wavefronts. Speech sound waves 1/4-inch from the lips are curved, so they activate the microphone. After traveling 1/2-inch or more, sound waves begin to flatten, and are heard more faintly by this special microphone. The mike has been designed especially for close-talking use in two-way radio communications.

Model 555 microphone (called the "Trucker") has a high-impact case;

coiled, three-conductor cable that can extend to eight feet; a press-to-talk switch; and a bracket for vertical or horizontal mounting. The ceramic element and solid-state amplifier are insensitive to temperature and humidity extremes, and the gain is adjustable. The unit is wired for electronic switching, but can be changed easily to relay-type talk-listen operation, if desired.



For More Details Circle (73) on Reply Card

### Controlled-Volume Intercom

An intercom system capable of providing up to 10 times the volume of conventional intercoms has been developed by **Talk-a-Phone**. The series furnishes controllable volume for communication with large or high-noise

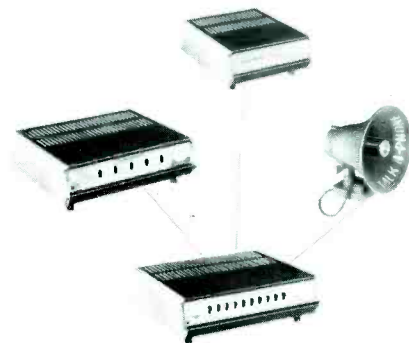

level areas, as well as small office areas. Included is a master selective intercom, consisting of one master station which can communicate with one-to-ten sub-stations, simultaneously. An optional cradle phone accessory is available, which provides listening privacy and diminishes background noise.

For More Details Circle (74) on Reply Card

### FREE ALARM CATALOG

Full line of professional burglar and fire alarm systems and supplies. 96 pages. 450 items. Off the shelf delivery, quantity prices.



mountain west alarm  
4215 n. 16th st., phoenix, az. 85016

For More Details Circle (28) on Reply Card

ELECTRONIC SERVICING



GET YOUR ALL NEW, BIG

## 1975 TV TECH AID COLOR TV BOOK

- Brand new, all-in-one book. Over 500 trouble shooting tech-tips.
- Covers all leading manufacturers, Admiral, Emerson, GE, Magnavox, Motorola, Panasonic, Philco, RCA, Silvertone, Sony, Sylvania and many others.
- Full schematic diagrams help you find symptoms, cause and cure of recurring troubles in all types of situations.
- Saves you time and money.

BACK ISSUES: GET 'EM WHILE THEY LAST!!  
SPECIAL REDUCED RATES

PLEASE SEND:  1970 Book Form \$3.00  1971 12 Issues \$3.00  1973 12 Issues \$3.00  
 1971 B&W Book \$3.00  1972 12 Issues \$3.00  1974 12 Issues \$5.95  
 1975 All New Color TV Book \$7.95

MAIL CHECK OR  
MONEY ORDER TO:

TV TECH AID

P.O. Box 603  
Kings Park, N.Y. 11754

ES12

Name.....  
Address.....  
City.....  
State..... Zip.....

For More Details Circle (19) on Reply Card



# photofact<sup>TM</sup>bulletin

PHOTOFACT BULLETIN lists new PHOTOFACT coverage issued during the last month for new TV chassis.

## ADMIRAL

Chassis M3008-2, M3012-2 ..... 1444-1

## BRADFORD

1004B44 (WTG-79384) ..... 1443-1

## CORONADO

TV2-2035A ..... 1441-1

## HITACHI

Chassis CRX ..... 1444-2

## JVC

3400, 3510 ..... 1441-2

## MGA

CS-196, CS-199 ..... 1442-1

## RCA

Chassis CTC51AE, CTC51AF ..... 1441-3

## SEARS

528.40590300, 528.40640300 thru  
528.40640305, 528.40720300 thru  
528.40720320 ..... 1443-2

## SHARP

C-1331 ..... 1442-2

## SONY

KV-1200U, TV-900UA,  
TV-940 (all late production) ..... 1441-4

## WARDS AIRLINE

UBD-11733A ..... 1443-3

## ZENITH

Chassis 19FB12, 19FB13 ..... 1442-3



Patent 3,778,713

**The Wayne Model WT2A**  
**■ makes YOU money**  
**■ saves much time**  
**■ makes trouble-shooting easier**

A new concept in transistor testing based on proven methods of circuit analysis. A current limited AC voltage is applied to each semiconductor junction under test. The resulting DC voltage is monitored while the rectifying junction is passing normal rated current. Abnormalities are easily identified.

- Indicates PNP or NPN
- Measures relative gain
- Test leads applied without prior basing knowledge
- Locates base and collector during test
  - Indicates silicon or germanium
  - Indicates transistor non-linearity
- In-circuit tests with shunt impedance down to THREE ohms
- Performs all of above and more in less than ten seconds

**WAYNE**  
**ELECTRONICS**  
 5412 Nordling St. / Houston, Texas 77022

For More Details Circle (20) on Reply Card

December, 1974

**LOOK TO *Lenk***  
**FOR YOUR**  
**SOLDERING**  
**TOOLS**

You'll find the right product at the right price in the Lenk line — made by long-time specialists in soldering equipment.



## CORDLESS

Battery powered. Built-in light. Fits easily into a tool box. Can be used while re-charging. Over 700°F tip temperature. Heats almost instantly. Very light — very useful!



## PENCIL TYPE IRONS

Lightweight, cool handles, screw-in tips.



## PACEMAKER

An instant type gun at low, low cost. Lightweight — no heavy transformer. Fast heating. Thermostatic action. Long, thin reach. Needs no stand, rests with tip upright. Interchangeable tiptip.

## AND OTHERS —

ALL MADE IN THE U.S.A. BY SKILLED CRAFTSMEN  
 See the Lenk line where quality soldering tools are sold

SINCE 1864

**WALL-LENK MFG. CO.**  
 WORLD'S LARGEST MANUFACTURER OF SOLDERING IRONS  
 KINSTON, N. C. 28501

For More Details Circle (21) on Reply Card



# bookreview

## Solid-State Ignition Systems

**Author:** R. F. Graf, G. J. Whalen

**Publisher:** Howard W. Sams & Co., Inc. 4300 West 62nd Street, Indianapolis, Indiana 46268

**Size:** 5-1/2 X 8-1/2 inches, 136 pages, catalog No. 21049

**Price:** \$4.50, softbound

Solid-state ignition systems rapidly are replacing the conventional Kettering ignition system, which has been used for more than 50 years by the automotive industry. The systems covered in this book include both the original equipment units and those offered as aftermarket products. Fundamental ignition requirements of the internal-combustion engine are discussed, as well as conventional systems. A practical review of solid-state theory helps to familiarize the reader with the operation of semiconductor devices. Inductive-discharge and various capacitive-discharge systems are covered, as well as troubleshooting and servicing the many types of ignition systems now in use. This book should be a valuable reference source for the professional who services ignition systems.

## Electronic Measurements Simplified

**Author:** Clayton Hallmark

**Publisher:** TAB Books, Blue Ridge Summit, Pennsylvania 17214

**Size:** 240 pages, 217 illustrations

**Price:** \$7.95 hardbound, \$4.95 paperback

Complete, simple explanations are provided on all tools of the electronics trade in this volume—VOMs, EVMs, voltmeters, ohmmeters, scopes, bridges, audio indicators, etc. Practical examples are included with clear, step-by-step procedures showing how to connect instruments, set knobs, and interpret the indications. The text includes a discussion of the measurement of basic electrical quantities: voltage, current, and power, covering all ranges and amplitudes. There is also full coverage of components measurements: resistance, inductance, and capacitance; plus a chapter on frequency measurements and signal sources. For those who want to know more about new digital-readout instruments, a chapter on electronic counters, DVMs, and their selection and use is included.

**Contents:** Measuring Electrical Parameters; Component Measurements; Bridge Circuits; Frequency Meters and Counters; Signal Sources; Synthesizers; Time Measurements; DVMs; Transducers; Measuring Displacement, Force, Acceleration, Pressure, Temperature and Light; Oscilloscope Principles and Operation; Transistor Gain and Leakage Currents; FETs, SCRs and Triacs; Advanced Scope Techniques; THD and IM Distortion; Antenna and Transmission Line Measurements; SWR; Microwaves; Bolometers and Mounts; and Smith Chart. □

# GC ELECTRONICS CALECTRO test meters



CALECTRO—A LOT OF METER FOR YOUR MONEY



**20 RANGE TEST METER**  
One of the most popular test meters at any price.



**19 RANGE TEST METER**  
A precision instrument in a small convenient size.



**16 RANGE TEST METER**  
Outstanding all-around test meter for technician or do-it-yourselfer.

INSTANT REPLACEMENT WARRANTY



**GC ELECTRONICS**

DIVISION OF HYDROMETALS, INC.  
ROCKFORD, ILLINOIS 61101 U.S.A. 

# antenna systems report

These features supplied by the manufacturers are listed at no-charge to them as a service to our readers. If you want factory bulletins, circle the corresponding number on the Reply Card and mail it to us.

## Antenna-Trouble Indicator

An automatic-indicating device designed to detect antenna problems in VHF communications equipment, has been announced by **Ascom Electronic Products**. Mobile communications antennas often are subjected to damage, and the problem usually is not detected immediately by the operator. Model ASM-104 alerts the operator and helps eliminate the possibility of an undetected antenna defect preventing communications from a difficult location. The device also helps prevent damage to equipment by eliminating long periods of transmission with extremely-high VSWR.



The antenna-circuit indicator is designed for easy mounting under the vehicle dash. Two LED lights are used to give instant indication of the system's operation. During transmissions, one light indicates the normal condition of RF power being transmitted. If the second indicator lights, a defect is causing power to be reflected. The unit requires 10 watts or more of RF energy and operates over a frequency range of 144-174 MHz.

For More Details Circle (75) on Reply Card

## Improved Antennas

The **Jerrold Electronics** line of Super Vu-finder all-channel antennas reportedly offers additional engineering advances. The antennas are of log-periodic design, which is especially suitable for color TV reception, because of the inherent flat response and good front-to-back ratio. Through extensive testing and computer-aided design, the antenna laboratory improved both parameters of the original design. Additional gain on all channels was obtained primarily by careful respacing of the elements. The most significant improvement was made in the front-to-back ratio and side lobe pattern of all Super-Vu finder antennas.

For More Details Circle (76) on Reply Card

## Coaxial Cable Clips

A dual clip from **Electrovert** can be used for securing two parallel RG 59 coaxial cables. Molded of high impact, shatterproof and shockproof polystyrene, the clips are reported to be ideal for securing the wiring of commercial sound, MATV, CATV, broadcast and telephone systems.

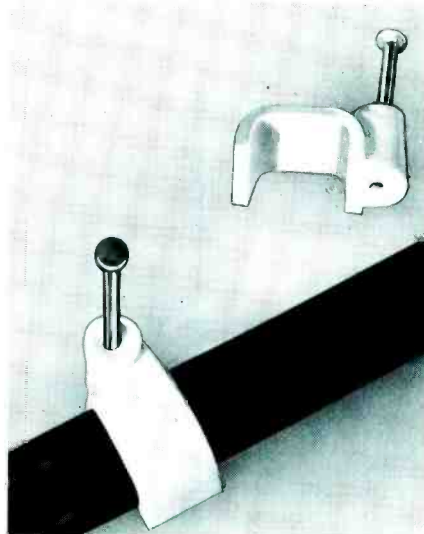

The dual-contoured design provides support without crushing the wires, which is particularly important in mounting coaxial cables. Deformation of coax cable can result in a poor signal. The clips sell for \$39.75/M.

For More Details Circle (77) on Reply Card

## Multi-Band Antenna Coupler

The **Gold Line Connector 1079** multi-band antenna coupler uses a standard car radio antenna to monitor 20-70 MHz, 148-175 MHz, and 250-470 MHz as well as an AM/FM car radio.



The antenna can couple up to five bands without a new or special antenna. Two cables are included for easy hook-up. The product sells for \$12.95.

For More Details Circle (78) on Reply Card

## MATV Demonstrator

A compact, portable display from **Jerrold Electronics** enables the technician to demonstrate easy designing of the "instant" MATV system. Mounted on one display board are

three head-end amplifiers and two splitters. The other plexiglass display board holds 12 omni-tap tap-offs, completely wired with attenuators simulating cable losses. To use the display,



connect to any good antenna and TV set for an instant demonstration. The effect of varying the isolation of omni-taps can be shown (omni-taps are screwdriver adjustable, 12-x to 25-dB isolation). The pre-engineered systems require no customer calculations—choose a package that fits the physical configuration of the building, and install.

For More Details Circle (79) on Reply Card

## "Super Cans" CB Antenna System

A new antenna system from **The Antenna Specialists** is designed to give maximum CB radio coverage. Model MR415 reportedly gives all-around coverage and minimizes severe directivity that may cause "dead spots". The system is named "Super Cans" because of extra large loading coils which are guaranteed against burnout. The coils are designed to run cooler than conventional coils, according to the company, and are protected inside special weatherproof cans. The overall antenna height is 53 inches, and may be mounted on any object up to 1-inch in diameter.

For More Details Circle (80) on Reply Card

## Directional Taps and Mini Splitters

**Q-bit Corporation** has introduced MH series miniature hybrid splitters and MD series miniature directional taps, designed for high-performance TV distribution systems. Rugged, low-loss units with a 5 to 300 MHz bandwidth, the devices are packaged in an aluminum housing with alodine finish for maximum shielding and resistance to corrosion. The units measure 1 X 1 X 1-7/8 inches and have threaded, 75-ohm "F" connectors. Available in either "T" or "F" configuration, the splitters and taps sell for \$1.75 each in quantities of 100.

For More Details Circle (81) on Reply Card

# reader's exchange

(Continued from page 11)

**Needed:** Updated tube charts for an Electronamic tube and set tester, Series 954-G.

Dale Bowman  
840 Oberlin Drive  
Heath, Ohio 43055

**For Sale:** 246 radio tubes, some as old as 1940 (OA2, OA3, etc.). Sell as one lot only; send for list.

R. Leiendecker  
22-10 Fort McNair  
Washington, D.C. 20024

**Needed:** Schematic and operating instructions for Eico Model 400 oscilloscope. Will copy and return.

Randy Kerbawy  
Route 1, Box 299  
Mount Hope, West Virginia 25880

**Needed:** Set-up booklet for Superior Instruments Model TD-55 tube tester (photocopy will do). Also, information or schematic on Stewart-Warner Model R10 radio, vintage 1933.

Dennis Gross  
3454 Shenandoah  
Dallas, Texas 75205

**Needed:** Schematic for amplifier in Bell & Howell Model 179, 16 mm sound projector.

Mel Coleman  
Allied T.V.  
3 Thames Street  
Groton, Connecticut 06340

**Needed:** Schematic for Symphonic Stereophonic Model KNT-4007 (has Garrard changer).

A. Antilla  
4066 Mount Everest Boulevard  
San Diego, California 92111

**Needed:** Operation manual for RF Signal Generator, Paco Model G-30.

Grady Wilson  
3610 Davis Street  
Texarkana, Texas 75501

**Wanted:** One classic sample of the largest B-W picture tube made. Write details.

Jerry Lee Martin  
P.O. 96  
Counselors, New Mexico 87018

**Needed:** Schematics for Sony Model CRR-4A wireless microphone transmitter, and Sony Model CRR-4A wireless microphone receiver.

S.F. McNeill  
3330 Wrightsville Avenue  
Wilmington, North Carolina 28401

**Needed for parts:** Channel Master solid-state B-W portable TV Model 6565. Doesn't have to operate, but must have good flyback and cabinet. Quote price plus FOB point.

Marc Tibbetts  
2608 Pepper Avenue  
Melborne, Florida 32935

**For Sale:** Riders radio manuals I-XX, many years of back issues of PF Reporter, several correspondence courses, and some test equipment. Ask for complete list and details; make offers.

Blackford's TV  
P. O. Box 52  
Brodhead, Wisconsin 53520

**Needed:** Schematic for a DeVon stereo model 5219. Also need an instruction book for a B&K dynamic mutual conductance tube tester model 700.

Jim Palmer  
P.O. Box 933  
Ephrata, Washington 98823

**Wanted:** Old radio manuals and text books; Rider manuals, factory material on early sets.

Larry Beitman  
Illini Tower, Room 610  
409 East Chalmers  
Champaign, Illinois 61820

## MINI-BAR<sup>®</sup> color generator

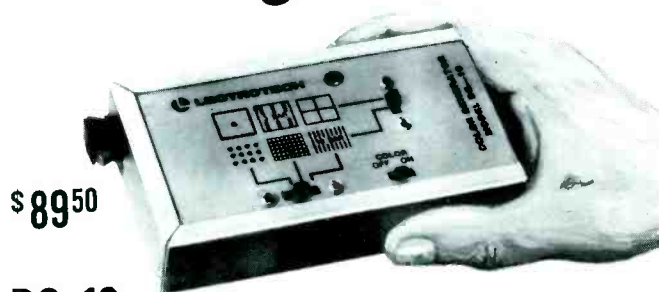

\$89.50

### BG-10 battery-operated, fits in shirt pocket!

No AC plug in . . . automatic on & off with LED indicator . . . fast, easy hook-up with coaxial cable . . . all essential patterns . . . • Low power consumption for extended battery life (Uses inexpensive 9 volt batteries) • Shuts off when not in use • Enclosed RF cable compartment • Size: 5 1/2" x 3" x 1 1/8". Only 12 ounces • TV station type sync signals • CMOS LSI IC for all counting functions . . . no internal adjustments • RF output on Ch. 3, 4 or 5.

BG-10 (less battery) . . . . . \$89.50  
CC-1 Carrying Pouch . . . . . \$ 2.95

See your distributor or write  
**LECTROTECH, INC.**  
5810 N. Western Ave.  
Chicago, Illinois 60659  
(312) 769-6262

Available in Canada  
from  
Superior Electronics  
Inc.

For More Details Circle (22) on Reply Card

# catalogs literature

Circle appropriate  
number on Reader  
Service Card.

**100. Littlefuse**—the line of "Little-lites" miniature lampholders is featured in a color catalog including detailed drawings complete with mounting dimensions, information tables, and a cross reference to military part numbers. An easy-to-use ordering table lists available options, special features, housing finishes, resistors, lens-cap styles, and colors.

**101. Sprague Electric Company**—has introduced a comprehensive revision of their Semiconductor Manual and Replacement Guide. The 64-page manual K-500A lists over 38,000 of the most popular domestic and foreign OEM semiconductor part numbers and their recommended replacement with 137 of Sprague's RT, TVCM, and ZT series semiconductors. All listings are alpha-numerical for simplified use of the manual. Also included is an extensive product guide section.

**102. Pageant/M.A. Miller Industries**—offers a 1974 catalog on Pageant-brand replacement needles. Illustrations and descriptions of more than 800 styles of needles in both sapphire and diamond types are included. The catalog makes it possible to locate a particular needle style by knowing either the cartridge number, phonograph model number, or the needle number of another manufacturer.

**103. Telematic**—makes available their 1974 catalog of test jigs, replacement parts and service accessories. The 16-page catalog offers many new items for the service market.

**104. Mountain West Alarm Supply Company**—has announced an alarm equipment catalog, A-75. The 96-page catalog describes over 450 intrusion-and fire-alarm products. Equipment offered ranges from simple kits with instructions,

to the latest ultrasonic, radar, and infrared intrusion detectors.

**105. RCA Electronic Components**—has released a revised product guide describing picture tubes for the renewal market. The guide, PIX-300H, includes directory which lists replacements for 975 industry types, plus over 85 foreign types. Basing diagrams, pictorial views illustrating safety feature constructions, and keys to tube sizes in the old, new, and foreign type designation systems are covered.

**106. International Rectifier Corporation**—makes available the 1974 edition of the semiconductor cross-reference and transistor data book. The 70-page brochure lists over 44,500 parts and corresponding replacements. The parts are indexed in straight alpha-numeric sequence for easy location. Also included are transistor specifications, showing polarity, case style, maximum current, typical bandwidth and gain, and price information.

**107. Eico Electronic Instrument Company**—has released a 6-page condensed catalog featuring its line of electronic test and measuring instruments. Over 100 electronic kits and factory-assembled instruments, including oscilloscopes, VTVM's, VOM's, generators, tube/transistor testers, and power supplies, are listed.

**108. Fordham Radio Supply Company**—has made available a 48-page illustrated, discount mail-order catalog, designed as a quick-reference ordering guide. Included are tools, service and repair kits, tubes, test equipment, phono cartridges and needles, speakers and microphones, antennas, components and other servicing aids. All products are shown with their discounted prices.

**109. Jensen Tools and Alloys**—offers a tool catalog with descriptions of over 2,500 items. The 112-page handbook includes sections covering tool kits, solder, technical data on tool selection, and tool "terms".

**110. Bernard Franklin Company**—announces a rack catalog which

includes technical information for the bulk storage rack. The rack is intended for large items too big or bulky for standard shelving. Models include heights to 12 feet, depths to 4 feet, and beams to 10 feet.

**111. Radio Shack**—introduces a 1975 Electronics Catalog 250, which lists hundreds of specialized electronics items, parts and accessories, tools, tubes and transistors, wire and cable, home security products, intercoms, microphones, timers, batteries, and a library of books on electronics and related subjects. The 164-page catalog has 100 full-color pages and introduces many products. □

(Continued from page 52)

## Solution to: ALL AROUND ELECTRONICS!

- |              |                |
|--------------|----------------|
| 1. Grille    | 17. OrangE     |
| 2. ExciteR   | 18. EchO       |
| 3. ReameR    | 19. OrthicoN   |
| 4. RecorD    | 20. NuvistoR   |
| 5. DefecT    | 21. RibboN     |
| 6. ToolS     | 22. NeutraL    |
| 7. SniveT    | 23. LuG        |
| 8. TransmiT  | 24. GhosT      |
| 9. TheorY    | 25. ThermioniC |
| 10. YagI     | 26. ClamP      |
| 11. InertiA  | 27. ParalleL   |
| 12. AmperE   | 28. LoktaL     |
| 13. ElectroN | 29. LubricanT  |
| 14. NovaL    | 30. ThyratroN  |
| 15. LouveR   | 31. Neutrino   |
| 16. RatiO    | 32. Ohm        |

Start with 128 points  
and deduct 4 points for  
any part you may not  
have answered correctly.

### Your rating:

- |           |                 |
|-----------|-----------------|
| 68 - 76   | Well-I-I-I.     |
| 80 - 92   | Pretty good.    |
| 96 - 112  | Very good.      |
| 116 - 124 | Excellent.      |
| 128       | <b>PERFECT!</b> |

Stop in for a pat on the back  
and we may even let you  
service our TV!

### OWN YOUR OWN PICTURE TUBE REBUILDING BUSINESS

With Lakeside Industries re-  
building equipment you can  
rebuild any picture tube!

For complete details send  
name, address, zip code to:

LAKESIDE INDUSTRIES  
3520 W. Fullerton Ave.  
Chicago, Ill. 60647  
Phone: 312-342-3399

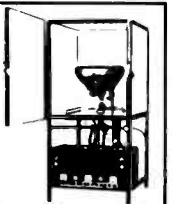

For More Details Circle (29) on Reply Card  
ELECTRONIC SERVICING

(Continued from page 17)

when color is desired.

By the other method, the chroma information is separated from the luminance signal and the two are treated separately. During playback, the color carrier is removed and heterodyned up to the normal 3.58 MHz.

No VTR directly can play back color. Color and luminance must be separated either during recording or playback, or both.

Cumulative effects of transport speed and phase errors are called "time-base errors" and they must be corrected by some ingenious and complicated circuits.

### Summary

The design and performance of a VTR which can provide good-quality color programs are miles ahead of those for an audio recorder. In fact, the requirements exceed those for color TV receivers.

Therefore, we recommend study and preparation before you attempt to repair or adjust any VTR's. The field appears to be extremely interesting; one that's worthy of the time and trouble necessary for you to become competent in it.

### Next Month

For Part 2, Mr. C. J. Dailing describes a typical good-quality VTR (Model 800 by IVC) and gives some of the maintenance and repair procedures. □

## GET COMPLETE DETAILS

**about the products advertised or described in this issue.**

**Use Free Reader Service Card.**

**Be sure to include your name and address**

## letters to the editor

(Continued from page 7)

Dear Editor:

*In reply to the quandry of Bellevue Radio and TV in the October issue regarding the many caddies of panels and modules required to service all makes of receivers.*

*We have eight service companies in our small town, covering an extensive rural area. We are tough competitors yet each of us is well aware that none of us can have all of the business so we are friendly competitors, all living in harmony.*

*All except one of the eight have solved the inventory problem by each firm stocking the panels and modules of one or two brands [the ones they are most frequently called to service]. Then, when the need arises to service a receiver for which we do not have the proper part, panel, or module, we "borrow" from the servicer who has that caddy.*

*As we are from 75 to 350 miles from distributors and wholesalers we are not able to drop in and pick up what we would need to make possible a reduced inventory. All of us are two- and three-man shops and do not feel we each can carry 5 or 6 caddies with about \$2000 worth of parts on the trucks, above the regular tube and parts inventory carried in the shops. Here we are even further hampered by the cost factor in that we have a California Inventory Tax, also!*

*Possibly this solution wouldn't work out in Bellevue, Ohio but it does very well in Porterville, California.*

Marc Partlow  
Porterville, California

Dear Editor:

*I have been reading a lot about warranty terms, inadequate warranty rates, and associated problems connected with performing in-warranty service for manufacturers. Some progress has been made, but we have not solved the problem, and I do not believe it will be*

**resolved in the very near future unless we get the retailers of these products on our side.**

*A year ago I decided that our service department could not continue to service these products for what the manufacturers were willing to pay, and that I, as one individual, could not force a change of warranty rates of any manufacturer. I also knew we needed this work, but at our going rate.*

*I felt that the real burden of in-warranty costs belong to the retailer, or at least that portion of the cost that the manufacturer would not pay. This includes not only those products covered by inadequate flat rate fees, but also nuisance calls on color TV's.*

*So, I wrote a letter to the department store and small dealers we do service for and explained the problem, advising them that as of that date we would bill them for any labor incurred in excess of the factory allowance. We bill our own sales department the same way. This method requires double billing on some repairs, but it is worth the extra effort.*

*The retailers of these products have more leverage than we do since they spend thousands of dollars with the manufacturer or his distributor. If they are forced to reduce their profit margin they will add their voice to ours, and then perhaps the manufacturers will be inclined to make some changes in warranty policies.*

*I am not advocating that anyone should do what we did, but it has worked for us. We are being paid our going rate and have lost very little business.*

Sincerely,  
Wayne R. Benninghoff  
Valparaiso, Indiana

**Editor's Note:** *Anyone have answers for these problems? Write to: Editor, Electronic Servicing, 1014 Wyandotte Street, Kansas City, Missouri 64105.* □

**Had a funny experience lately? Send details to Reader's Chuckles**

## The MARKETPLACE

This classified section is available to electronic technicians and owners or managers of service shops who have for sale surplus supplies and equipment or who are seeking employment or recruiting employees.

### Advertising Rates

in the Classified Section are:

- 25 cents per word (minimum \$3.00)
- "Blind" ads \$2.00 additional
- All letters capitalized 35 cents per word

Each ad insertion must be accompanied by a check for the full cost of the ad.

Deadline for acceptance is 30 days prior to the date of the issue in which the ad is to be published.

This classified section is not open to the regular paid product advertising of manufacturers.

## FOR SALE

**INCREASE EARNINGS**—YOU deserve more for your expert electronics know-how. Service Contract Cookbook, and, Practical Home Electronics Business Manual tell how. Either book, \$15.00. Both ordered at same time, \$25.00. Prepaid. NATESA SCOPE, 5908 S. Troy St., Chicago, Ill. 60629. 12-74-3t

**TV & RADIO TUBES** 36c EA!! Free color catalog. Cornell, 4221 University, San Diego, California 92105. 10-74-6t

**NEW** Canadian Magazine "Electronics Workshop", \$5.00 yearly. Sample \$1.00. Ethko, Box 741, Montreal "A" Canada. 10-74-12t

**UNUSUAL SURPLUS AND PARTS** Catalog. \$1. ETCO Electronics Dept. E.S., Box 741, Montreal "A" H3C 2V2. 12-74-12t

**SUPERABUNDANT:** clean up towels. 30 for \$1.50. Red Clay Mountain, 524 Woodland Dr., Clarksville, Tenn. 37040. 12-74-1t

**RCA** Crystal calibrated marker generator WR-99A, sweep generator WR-69A. New, never used, with instruction/warranty. Additional electronic/audio list. Write Lawtronics, Route 1, Box 415A1, Swansboro, North Carolina 28584. 12-74-1t

**ANTIQU** radio material. "Most-Ofen-Needed 1926-1938 Radio Diagrams," \$7. Also 1940, 1941, 1942, only \$4 each. Lawrence Beitman, 409-E Chalmers, Champaign, Illinois 61820. 12-74-1t

## EDUCATION-INSTRUCTION

**REPAIR TV TUNERS**—High Earnings: Complete Course Details, 12 Repair Tricks, Many Plans, Two Lessons, all for \$2. Refundable. Frank Bocek, Box 3236 Enterprise, Redding, Calif. 96001. 12-74-6t

## BUSINESS OPPORTUNITY

**THRIVING** Radio/TV Sales and Service Business in growing resort town of Steamboat Springs, Colorado. Includes inventory, test equipment, tools, and van. Contact 303-879-0728 or write Big Country Realty, Box 173, Steamboat Springs, Colorado 80477. 12-74-1t

## advertisers' index

B & K Div., Dynascan Corp .....	3
Busmann Mfg. Div., McGraw-Edison .....	21
Castle TV Tuner Service .....	Cover 4
Eico Electronic Instruments Co., Inc. ....	7
Enterprise Development Corp. ....	8
GC Electronics .....	53
General Electric Company .....	25
German Electronics Service Corporation .....	48
Heath Company .....	11
Jensen Tools and Alloys .....	48
Jerrold Electronics Corp. ....	Cover 3
Lakeside Industries .....	56
Lectrotech, Inc. ....	55
Motorola Training Institute .....	49
Mountain West Alarm Supply Co. ...	50
Oneida Electronics Mfg. Co. ....	49
Perma Power .....	47
Precision Tuner Service .....	Cover 2
Sperry Tech, Inc. ....	32
Sprague Products Company .....	9
GTE Sylvania - Consumer Renewal .....	1
T & T Sales Company .....	46
TV Tech Aid .....	50
Tektronix .....	29
Telematic .....	8
Tuner Service Corporation .....	5
Vu-Data Corporation .....	19
Wall-Lenk Mfg. Co. ....	51
Wayne Electronics .....	51

### MOVING?

Send your new address to:

Circulation Dept.  
Electronic Servicing  
1014 Wyandotte Street  
Kansas City, Missouri  
64105

# He has a new view of life



He saw for himself how modern coronary care units, more effective drugs and new methods of rehabilitation helped him beat the big one — heart attack.

Research scientists, many helped by your Heart Fund dollars, made these advances possible.

For greater advances in treatment and prevention . . .

Help your  
**Heart...**

Help your  
**Heart Fund**   
American Heart Association

Contributed by the Publisher



*Proved in the lab! . . . approved in the field!*

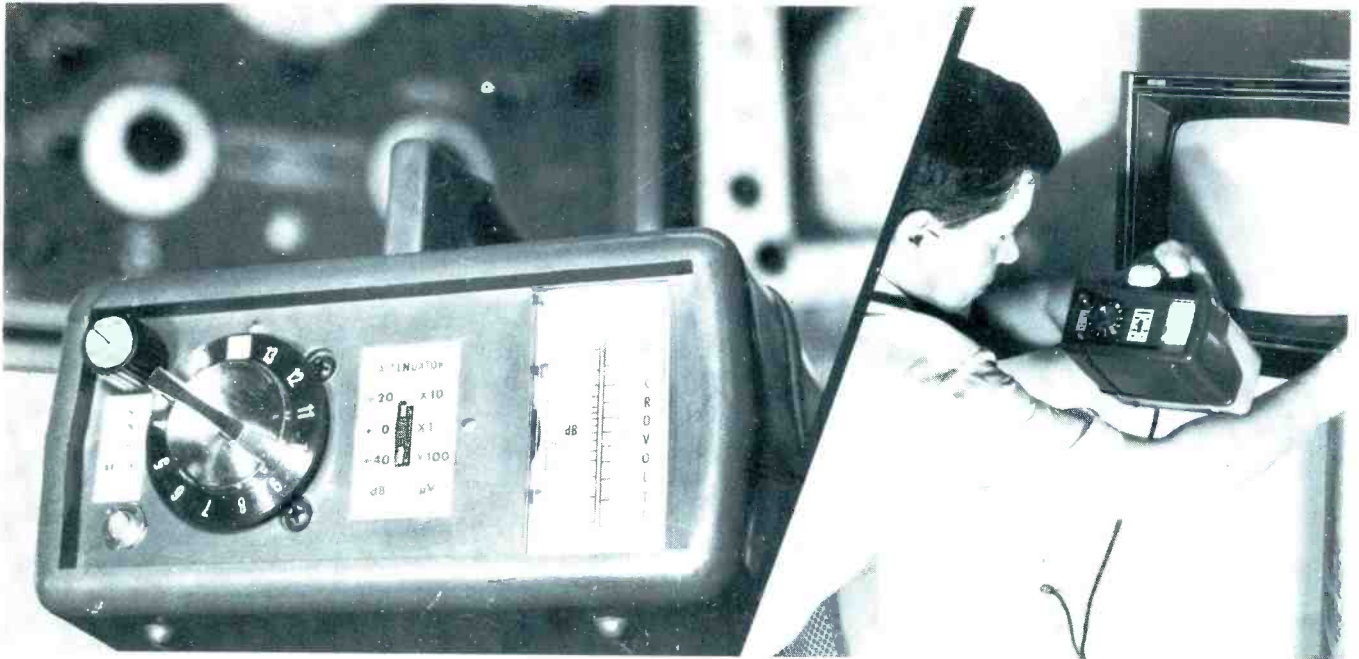

# *The NEW MEZZNER*™ TELEVISION FIELD STRENGTH METERS

Invaluable for

- Antenna installation
- Antenna evaluation
- MATV
- CATV
- Output calibration of TV signal generators and similar signal sources

The instruments use two 9v alkaline transistor batteries for field use, plus inbuilt power supply with wall plug-in transformer for 120vac operation.

## VHF Model FSM - V net \$119.95

Range: 20 microvolts to 100 millivolts  
Meter: Scale calibrated in microvolts (linear) and dB (log.). Ref: 0dB = 1 millivolt. Full scale basic range 1 millivolt  
Attenuator: X 1 (+ 0dB); X 10 (+ 20dB); X 100 (+ 40dB)  
Tuning: All 12 VHF channels  
Inputs: 75 ohms - "F" connector; 300 ohms - screw terminals  
Accuracy:  $\pm$  3dB typ.



## UHF Model FSM - U net \$99.95

Range: 20 microvolts to 10 millivolts  
Meter: Scale calibrated in microvolts (linear) and dB (log.)  
Attenuator: X 1 (+ 0dB) and X 10 (+ 20dB)  
Tuning: Full UHF band, Ch. 14 - 83  
Inputs: 75 ohms - "F" connector; 300 ohms - screw terminals  
Accuracy:  $\pm$  6dB typ.



These instruments boast the extra features of all Castle products-advanced technology-modern styling-and they work!

Ask your electronic distributor for them . . . or write for more details.



**CASTLE TV TUNER SERVICE, INC.**

5701 N. Western Ave., Chicago, Ill. 60645 • Ph. 312-561-6354

In Canada: Len Finkler Ltd., Ontario

For More Details Circle (3) on Reply Card

Jim is one of the busiest antenna installers in Pennsylvania. He does work for 17 major appliance dealers. But the bulk of his antenna sales come from his own advertising, yellow page listings and word-of-mouth recommendations from satisfied customers.

**JERROLD**   
a GENERAL INSTRUMENT company

Jim doesn't try to be the cheapest — only the best. He stresses quality of workmanship plus quality of materials. With this philosophy and a lot of hard work, Action Sales has doubled sales volume each of the four years since Jim started the business.

"My reputation means everything to me," says Jim. "That's why I'm so delighted with the performance and durability of the Jerrold Super VU-Finder line. My customers aren't much interested in the technical specifications. But, they do want excellent color quality without interference and no problems from their antenna. And that's what Super VU-Finder delivers."

For more information on the Super VU-Finder line, contact your local Jerrold Distributor or ...

**JERROLD ELECTRONICS CORPORATION**  
**Distributor Sales Division**  
P.O. Box 350  
200 Witmer Road, Horsham, Pa. 19044

**THE JERROLD  
SUPER  
VU-FINDER  
IS THE FINEST  
ANTENNA  
EVER BUILT!**

**SAYS JIM WELLENER  
ACTION SALES  
FEASTERVILLE, PA.**

